

VOICEMEETER BANANA

Advanced Virtual Audio Mixer for Windows



USER MANUAL

OFFICIAL WEBSITE
www.voicemeeter.com

This Document explains the additional functions added in Voicemeeter Banana (Voicemeeter pro version) .

if you are not familiar with Voicemeeter, we recommend to read first the User Manual of Voicemeeter Standard version.
www.voicemeeter.com

INSTALLATION:

Run setup program and follow instructions.

Reboot after installation or uninstallation

FIRST INSTALLATION

As prerequisite, you might have administrator rights otherwise you may run the setup program in administrator mode.

- 1- Run the Setup program and push the button INSTALL.
- 2- If already installed, push the button REMOVE.
- 3- REBOOT AFTER EACH OPERATION (IMPORTANT).
(Virtual Audio Device Driver needs this reboot to finalize uninstallation or installation)

HOW TO UPDATE

Update requires you uninstall Voicemeter first. You can save your current Voicemeeter settings in a file before, but it should normally stay as it is (current settings are not deleted by the setup process):

As prerequisite, you might have administrator rights otherwise you may run the setup program in administrator mode. Close applications that could use Voicemeeter Remote API (Touch portal, Elgato Steam Deck...).

- 1- Run the Setup program and push the button REMOVE.
- 2- REBOOT AFTER (IMPORTANT)

Before re-installing you may check different points:

- In Windows Device Manager you may check that all voicemeeter virtual audio drivers are removed (from the game controller section and from the audio I/O section) - if still present you will have to uninstall them manually from there (right click to get menu option).

- In Windows Sound Dialog box Playback / Recording devices list: Voicemeeter virtual device are surely not present anymore but you may check that possible VB-CABLE are still well installed with the right name and icon.

more info on our forum: <https://forum.vb-audio.com/viewtopic.php?f=7&t=688>

THEN RE-INSTALL:

3- Run the Setup program and push the button INSTALL.

4- REBOOT AFTER (IMPORTANT)

Then you may:

5- Check Windows audio parameters (default playback device, default recording device...)

6- Check soft phone parameters (for example Skype / Zoom / Discord audio device selection).

7- Run the wanted Voicemeeter version and reply to firewall authorization (if VBAN service is running).

8- Possibly re-check some option in menu (System Tray, Run at Startup, Show App on Startup...).

ONLINE SUPPORT

<https://vb-audio.com/Services/support.htm>

Fair Trade, Affordable For Everyone

Voicemeeter is a donationware, free to download and free to use!
It allows you to adjust the license price according to your means or usage.

Thanks for your participation and support!

<https://shop.vb-audio.com>

Windows XP (SP2), VISTA, WIN7, WIN8, WIN8.1, WIN10 32/64 bits
(MME, DX, WDM/WASAPI, KS, ASIO).

www.voicemeeter.com / www.vb-cable.com

Table of Content

INTRODUCTION:	7
Voicemeeter Banana as Universal Virtual Audio Device:.....	9
Voicemeeter as Audio HUB and Next Gen Audio Engine:	10
Quick Startup Guide.....	11
Remarks in case of problem:	11
Connecting Voicemeeter to Audio device:.....	12
Selecting Input Devices.	13
Using Voicemeeter Virtual I/O in one picture:	14
Voicemeeter Virtual ASIO driver.....	15
Audio Controls.....	16
Position 3D Panel: The Binaural effect.....	16
Modulation Fx.....	17
Compressor / Gate.....	17
Equalization / 5.1 Pan Pot.	17
Strip Limiter.	17
M.C Button.	18
Karaoke Button.	18
Master Section: BUS Assignment.....	19
Master Section: Output BUS.....	19
BUS Master Parametric EQ.....	20
Special Routing Options on Output BUS.	21
COMPOSITE.....	22
All Voicemeeter BUS Mode (12):	23
ASIO Routing Capabilities.....	25
Integrated Recorder.....	26
Recording Options	26
Menu for Extra functions	28
Other Voicemeeter Tools & Accessories:.....	29
VBAN: VB-Audio Network	31
Open VBAN Configuration dialog box:	31
VBAN Services / Identification.....	33
Configure VBAN Audio Stream	34
Send audio stream to other computer / device:	34

Receive audio stream from other computer / device:.....	34
Additional VBAN-MIDI or Command stream.....	35
VBAN2MIDI application.....	35
MACRO Buttons.....	38
Configuring MACRO Buttons	39
Button Color	40
Voicemeeter Remote Requests	40
Input Strip Parameters:	41
BUS Parameters:	42
Special functions to make timed fade in/out:	43
System Settings Option:	43
Tape Recorder Options:.....	44
Special Commands:	44
Button command for button interactions	45
Wait command to create sequence of requests.....	45
Load Button map.....	45
VBAN Options:	46
AUTO Ducking (Trigger):.....	47
HID Manager:.....	48
GPIO:	49
System Functions (to send command to Windows):	50
System Execute	50
System KeyDown / KeyUp / KeyPress	51
List of Key Name:	52
Send M.I.D.I. Message.....	52
Send VBAN-MIDI or VBAN-TEXT (Voicemeeter script).....	54
Send MIDI command through VBAN Stream.....	55
Send Voicemeeter TEXT Request through VBAN Stream.....	55
Manage your lights Network in DMX 512	56
Voicemeeter Remote API (for developer only)	57
System Settings / Options	59
ASIO Driver support:	61
Getting Optimal Latency:	61
LATENCY WARNING:.....	62
Patch Composite.....	62
Patch Insert.....	63

M.I.D.I. Mapping:.....	64
MIDI Feedback:	65
MIDI Forward:.....	65
MIDI Advanced Feedback:.....	66
Specifications:.....	67
Voicemeeter Banana I/O Diagram:.....	68
KNOWN ISSUES / RECOMMENDATIONS	69
No sound anymore on my computer!	69
Voicemeeter does nothing if you don't use it	69
Output A1, A2 ... are not exactly synchronized.....	69
Voicemeeter Audio Stream can be stopped (no more sound, no meter display).	69
Voicemeeter Audio Engine works only if a device has been selected for output A1.	70
Audio Stream becomes bad (sound is choppy, crackling, discontinued):	70
Windows Update can disturb the audio stack:.....	70
VB-Audio Device Checker:.....	71
Audio Device List:.....	71
Command Line Installation:.....	73
Voicemeeter Command Line:	73
Registry Parameters:.....	74

INTRODUCTION:

Voicemeeter Banana is an advanced virtual mixing console able to manage 5 audio inputs (3 physical and 2 virtual) and 5 audio outputs (3 physical and 2 virtual) through 5 multichannel busses (A1, A2, A3 & B1, B2).

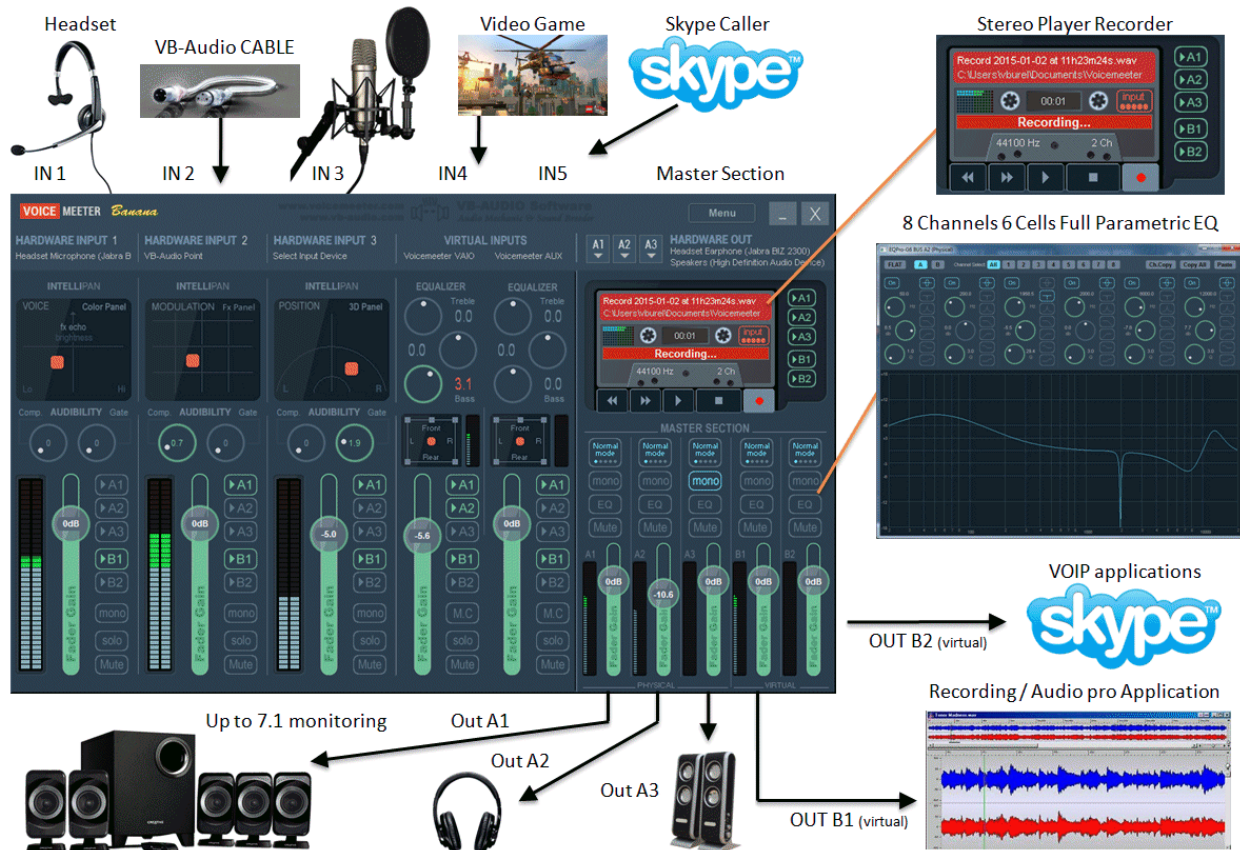

As Mixing Console, Voicemeeter offers large amount of use case combinations: To mix in real time your voice with your music, your movie, your video game or web radio and share it on internet through VOIP applications. Voicemeeter is also able to let you manage 3 Headsets and create new VOIP experiences ...

Voicemeeter Banana integrates an audio recorder able to generate BWF, WAV, AIFF, or MP3 file in stereo. (and 4, 6, or 8 channels for WAV / AIFF format). Recording options allow recording any pre-fader inputs or post fader BUS. Special Composite Mode will allow to record pre or post fader inputs in multichannel mode.

Voicemeeter Banana offers a 6 cells full parametric EQ on every BUS, with the possibility to make independent equalization on each channel (1-to 8). This is made to correct your P.A. System from mono to 7.1 setup. In conjunction with Stereo Repeat Mode, it 's also possible to use this Equalizer as stereo Cross Over to drive 2, 3, or 4 ways active speakers system.

Finally Voicemeeter Banana provides a better control on Compression / Gate effect by presenting 2 different knobs and adds another modulation effect panel on the 3 physical input strips.

Voicemeeter Banana implements a simple matrix to let you manage input to output routing, and make mix minus processing for every strips. So we have 5 push buttons per strip: A1, A2 A3 and B1, B2 to send each strip to assign any audio source to any busses.

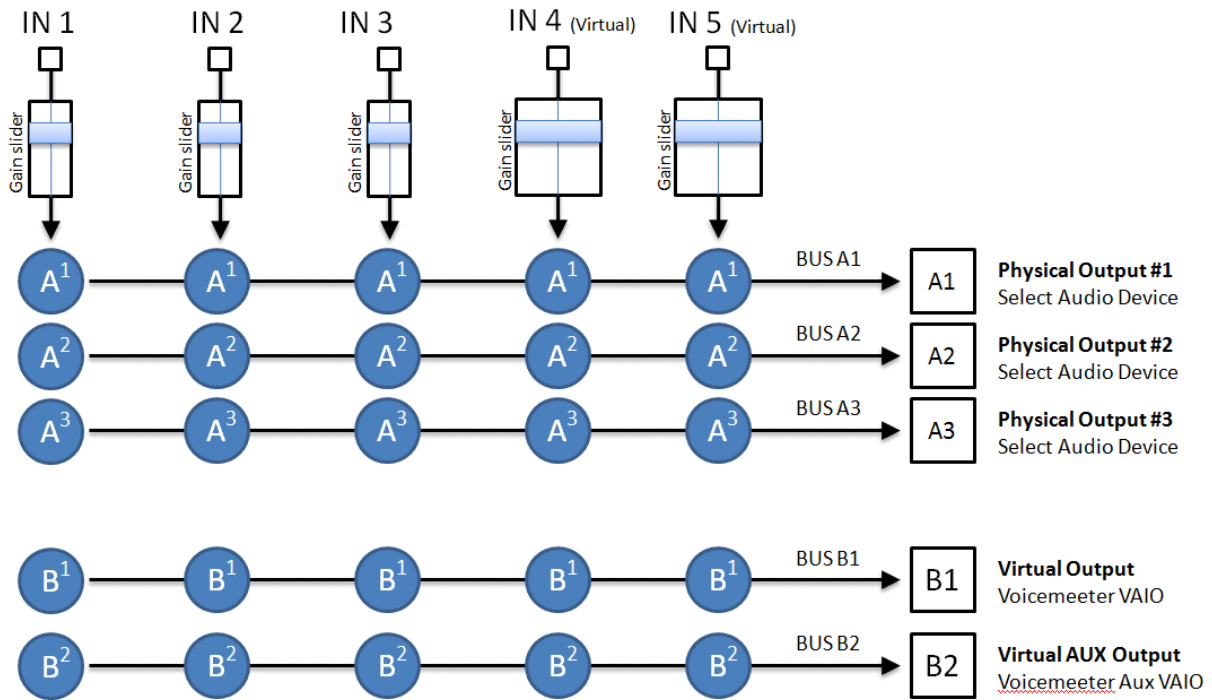

Voicemeeter Banana General Diagram (5 inputs / 5 Buses / 5 outputs Mixing Console)



Voicemeeter Banana as Universal Virtual Audio Device:

Voicemeeter offers Virtual Audio Point on Input #4 & #5 and on BUS B1 and B2. These Virtual Audio I/O's (VAIO) support all possible Audio Interfaces and allows connecting any audio applications, including audio pro DAW or musical instrument working with ASIO devices.

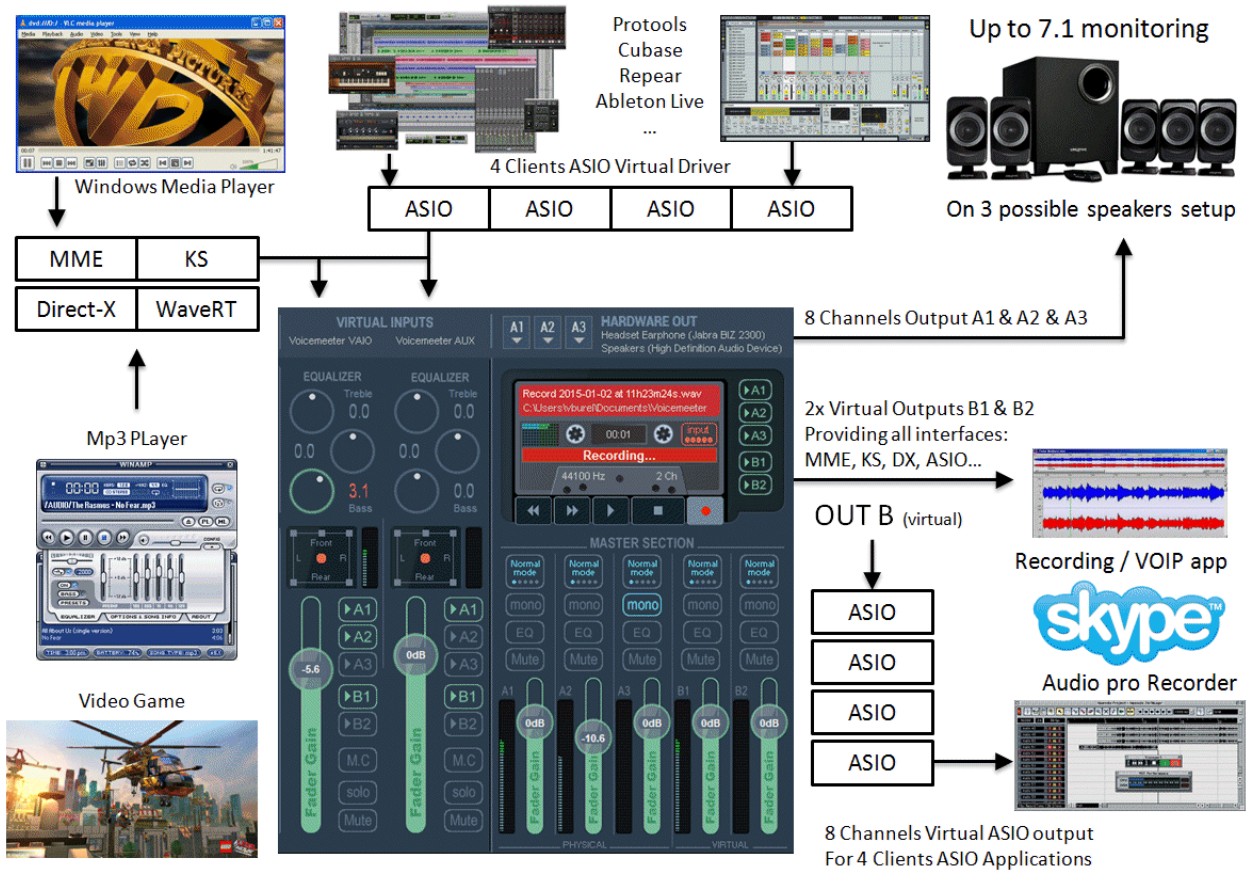

Audio interfaces type supported by Voicemeeter Virtual audio I/O (Voicemeeter VAIO).

Interface Type	Description
MME	The MME API or the Windows Multimedia API (also known as WinMM) was the first universal and standardized Windows audio API. This audio interface type is expected to work with whatever audio device but with latency time possibly around 100ms.
WDM	That we call WDM (Windows Driver Model) audio interface in Voicemeeter is handled by WASAPI : the Latest Microsoft Audio Functions to get best audio performances and small latency (< 30ms) – available since Windows VISTA
KS	Kernel Streaming or Direct Kernel streaming API allows low latency audio streaming, since Windows XP, but unfortunately not all audio devices provides this interface.
WaveRT	The WaveRT miniport driver is supported in Windows Vista and later Windows operating systems and can offers good audio performances and small latency (comparable to KS).
Direct-X	Direct-X Audio Interface is used by Video Game and some audio software. Latency is usually comparable to MME,
ASIO	Audio Stream Input/Output (ASIO) is a computer sound card driver protocol for digital audio specified by Steinberg, providing a low-latency and high fidelity interface between a software application and a computer's sound card.

Voicemeeter as Audio HUB and Next Gen Audio Engine:

Voicemeeter now includes VBAN features and Voicemeeter Remote API. VBAN allows to send / receive audio stream to / from any computers of a local network. Voicemeeter Remote API allows developing client applications and taking advantage of all Voicemeeter features, inter connection with all audio interfaces type, audio device aggregation, mixing/routing functions, MIDI and VBAN features, to create new powerful audio applications.



Voicemeeter is installed with Macro Buttons Application offering programmable buttons to act on Voicemeeter by simple request script

Voicemeeter package also installs VoicemeeterRemote.dll and VoicemeeterRemote64.dll for client application willing to control Voicemeeter by program.

More information and SDK download on our forum:

<https://forum.vb-audio.com/viewtopic.php?f=8&t=346>

Quick Startup Guide

Voicemeeter is a virtual audio mixer intended to replace the Windows Mixer. The quickest way to configure Voicemeeter is to simply use it as default device and connect it to your main playback device. Then all PC sounds will go through Voicemeeter before playing back to your speakers.

1 Install Voicemeeter...



...and REBOOT your computer

2 Configure default Audio Device...



...set Voicemeeter Input as default

3 Launch Voicemeeter Application...



...select Audio Device for output A1

4 Set Voicemeeter In System Tray...



...to replace Windows Audio Mixer

Remarks in case of problem:

Installing Voicemeeter means installing audio driver. In some cases, the system might declare this new driver as default driver (as default playback device for example). Consequently you do not hear anything anymore since you do not run and configure Voicemeeter and your system audio correctly (as it is shown above).

Windows System Audio Configuration is mainly located in Windows Control Panel / Sound Dialog Box. This is where you have to go to check or set what is your default playback device and what is your default recording device (and the Communications option has to be set to "Do Nothing" if you use Voicemeeter with VOIP applications).

In all cases, all is a question of audio configuration and it does not need to remove Voicemeeter in case of problem. Voicemeeter is a simple Application endowed with an audio device driver, if you don't use it, there is no way to get trouble. But if you do, you need to avoid possible audio device conflict and connect everything to Voicemeeter (to prevent other application to use audio playback device already used by Voicemeeter).

Connecting Voicemeeter to Audio device:

To make Voicemeeter working, you need at least to select the main output device used for BUS A1. We recommend to select your best audio device here because it will be considered as the master Audio Point giving the master sample rate and buffer size. ASIO or WDM device type usually allow to get best performances (ASIO is present only for output A1).



The main audio output device A1 can work in 32 kHz, 44.1 kHz, 48 kHz, 88.2 kHz, 96 kHz, 176.4 kHz or 192 kHz. This sample rate will be used for all mixing processing and Virtual ASIO points (Voicemeeter will support any sample rate on other inputs or outputs points).

REM: If selecting an ASIO device for output A1, Voicemeeter's inputs strips (if not already set) will be automatically connected to related ASIO inputs (2 by 2) - until you select another audio device on hardware inputs – Then it's possible to use a single ASIO board to manage 5x stereo input and 5x output BUS (output BUS supports up to 8 channels – see ASIO channel assignation in system settings dialog box).

Selecting Input Devices.

An audio device can be selected for every physical strip by clicking on hardware input strip section. Select audio input device on strip #1, for example your microphone! Then you will be able to listen to your voice in real time.



As you can see on this picture, Input 1 and 2 use default ASIO device input (since it has previously been selected as main audio device for output A1). But it does not prevent to select another audio device input (from another audio device).

REM: it's better to select WDM driver (present since Windows VISTA) to get best latency and audio performances. If using MME driver you might have a bigger delay between input and output. Use MME driver only if WDM are not present or does not work correctly with your audio hardware configuration.

KS can be better than WDM in some cases but not all audio devices are presenting such audio interface. In the example above, Jabra BIZ 2300 USB Microphone and onboard Audio Device are not present as KS device, but only in WDM and MME.

Using Voicemeeter Virtual I/O in one picture:

Virtual I/O are connected to virtual audio devices installed with Voicemeeter. Playback devices are used as virtual inputs while recording devices are fed with output B1 and B2 (the B Busses).

VoiceMeeter Virtual Inputs are directly connected to Voicemeeter Virtual Audio Playback Devices

VoiceMeeter Busses B1 & B2 are directly connected to Voicemeeter Virtual Audio Recording Devices

Voicemeeter Virtual ASIO driver

Each Voicemeeter Virtual I/O also supports an ASIO interface able to manage 4 client applications. These 4 possible sources get signal from BUS B1 (for Voicemeeter Virtual ASIO) or BUS B2 (for Voicemeeter AUX virtual ASIO) and their outputs are mixed together on the related Virtual Input (with possible PC Sound already coming from usual windows audio interfaces).

All ASIO Clients receive the same audio signal coming from BUS B1 or B2

All ASIO Client outputs are mixed on Voicemeeter Input 4 or 5 with possible audio coming from other PC applications

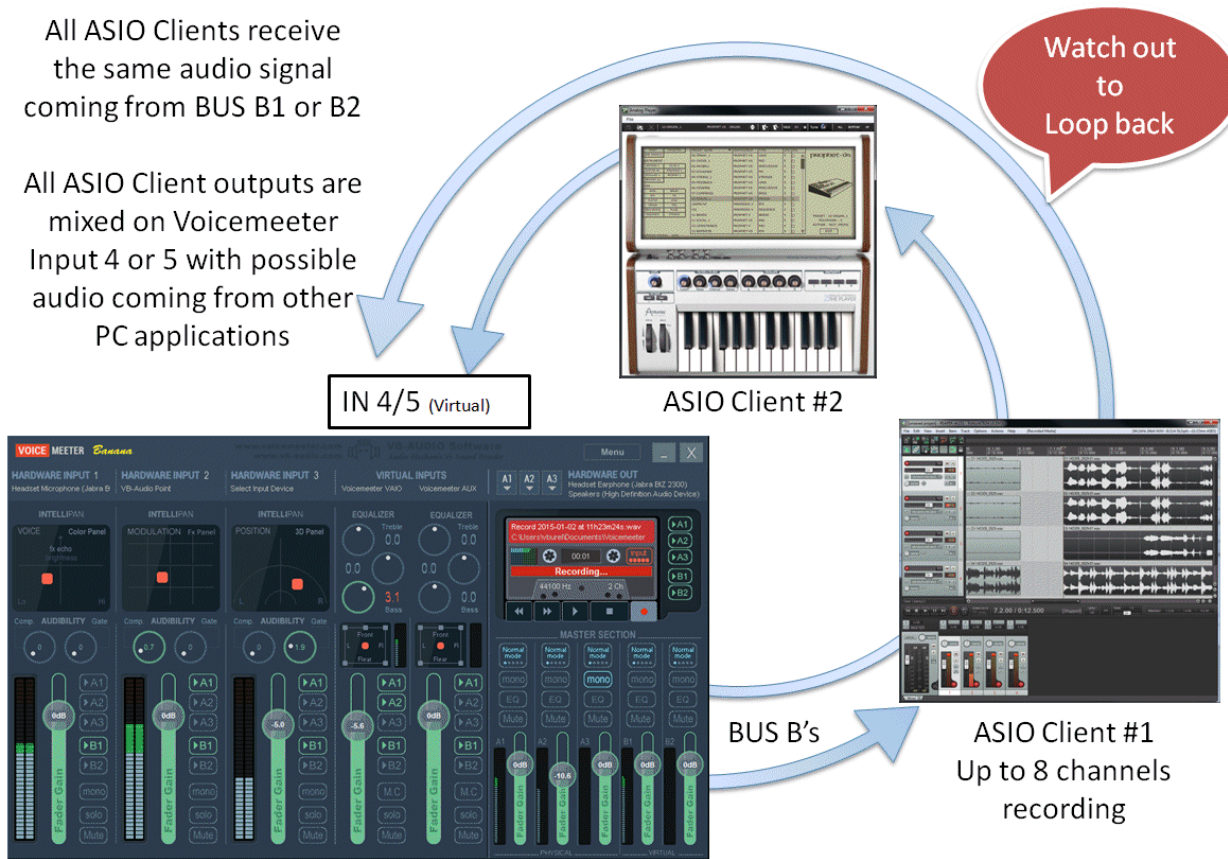

For Recording Applications, take care about the loop back! You might have MUTED outputs or disable monitoring otherwise output signal will come back on input infinitely.

Configure DAW Application

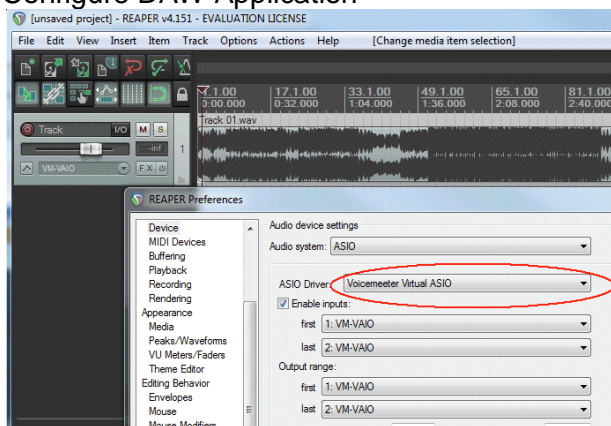

Select Voicemeeter Virtual ASIO device In any audio applications supporting ASIO

Configure Musical Instrument

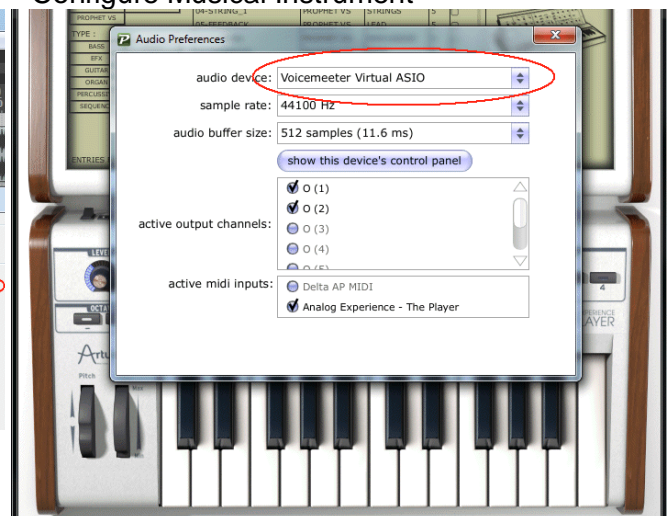

Audio Controls.

While you are talking you can tweak your voice in real time with different controls; 2D Panel, Audibility knobs or simple 3 bands Equalizer...

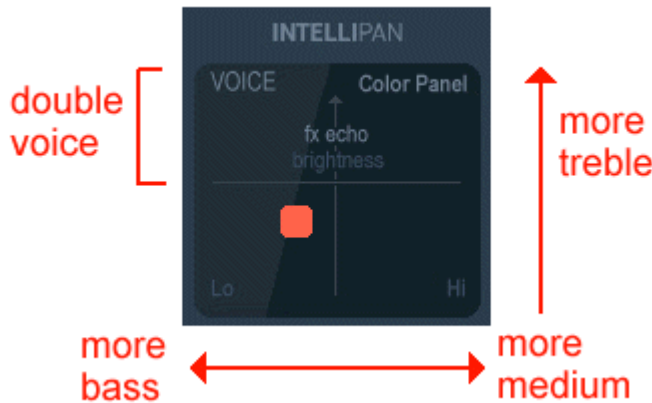

INTELLIPAN COLOR PANEL

Based on basic equalizer, this panel will allow you to change the color of your voice in a quick way.

It gives a spectral identity to your voice by acting on 3 frequency bands and a tiny reverb on the half top.

Position 3D Panel: The Binaural effect.

If you right click on panel you can switch to another effect able to position audio sources with a simple room effect (works in stereo only).



Voicemeeter includes a binaural effect able to give a spatial identity to audio sources and then increase dialog intelligibility (especially when everyone is talking in the same time).

This effect works in stereo, so can be used when recording a stereo stream to improve the sound of the global mix. This also can be used to simply enhance your voice to stereo.

This kind of “psycho acoustic” effect is used a lot since decades in audio production to create a better “audio scene” by positioning some music tracks on different virtual location. Today several FOH live mixing consoles are proposing such advanced Pan Pot, mainly because it allows saving audio energy – while the regular pan pot could completely remove the sound from left or right.

Modulation Fx.

If you right click on 2D Panel you can also get the Modulation panel below.



Based on Chorus effect, this panel allows to make various effects. Just experiment by placing cursor wherever you want. Basically chorus / phasing effect are on the bottom while modulations are on the top. Modulations with feedback are on the left side while simple modulation is on the right side. Depth is given by the distance to the middle of the panel.

Compressor / Gate.

On each input strip there are two knobs to set compression and gate effect.

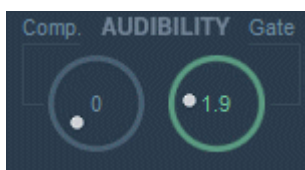

Compression is made with “auto make up”. Consequently it gives a big boost to your voice while compressing it. Then you can adjust the compression gain by decreasing the fader gain.

Equalization / 5.1 Pan Pot.

On both Virtual input strips, there is a simple 3 bands Equalizer and 5.1 Pan Pot.



EQUALIZER

3 Bands Equalizer to boost or remove bass, medium and high frequency (treble).

5.1 Pan POT

Below the Equalizer a small 2D Panel allows 5.1 balance. It's a simple process to position the sound source in one of your 5 speakers:

- front left
- Front Center
- Front Right
- Rear Left
- Rear Right

Strip Limiter.



With Voicemeeter Banana comes a Brick Limiter on each physical or virtual strip to define a threshold for each audio source. Click directly in the meter bar to set the limit by the mouse or right click to enter the value directly (-40 to +12 dB).

Trick: All controls go back to default value if double click on it!

M.C Button.

M.C. Button is made to mute the center channel on virtual input on a 5.1 or 7.1 audio material, coming from DVD for example. This is the button to mute the channel 3 (CENTER) containing the dialogs of the movie. Then it is possible to make real time movie dubbing by using this button as this video tutorial is showing it: <https://youtu.be/EdnD8b6n-Fw>

Karaoke Button.

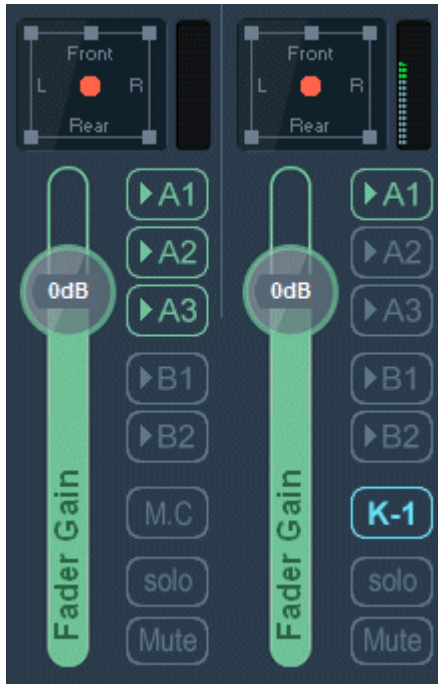

With Voicemeeter Banana version 2.0.5.3 and Potato version 3.0.1.3 comes a K button on Virtual AUX input to offer 4 different real time algorithms to remove the voice on a stereo material..

K-m: Karaoke Voice Remover

Removes the common part of a stereo track material. All mono sound will be removed

K-1: For some material, other sounds than voices can be removed, so the K-1 mode will keep some bass and treble.

K-2: Like the K-1 mode, K-2 mode will keep more bass and more treble.

Kv: If nothing works (like on a MONO track), this last mode will simply remove the voice frequency range (200-4000 Hz) by a simple filter



- K-m** **Karaoke Voice Remover:**
Removes the common part on a stereo track in real time.
All mono sound will be removed!
- K-1** **Karaoke K-1:**
For some material, other sounds than voices can also be removed.
So the K1 mode will keep bass and treble.
- K-2** **Karaoke K-2:**
Like the K-1 mode, K-2 mode will keep more bass and more treble.
- Kv** **Karaoke Kv:**
If nothing works (like on a mono track), this last mode will simply remove the voice frequency range (200Hz - 4000 Hz) by a simple filter.

Voicemeeter K-Button



Master Section: BUS Assignment.

The Master section allows managing all outputs BUS. BUS A1, A2, A3 are connected to physical audio device while BUS B1, B2 are connected to related virtual audio output (appearing as recording device in Windows system).

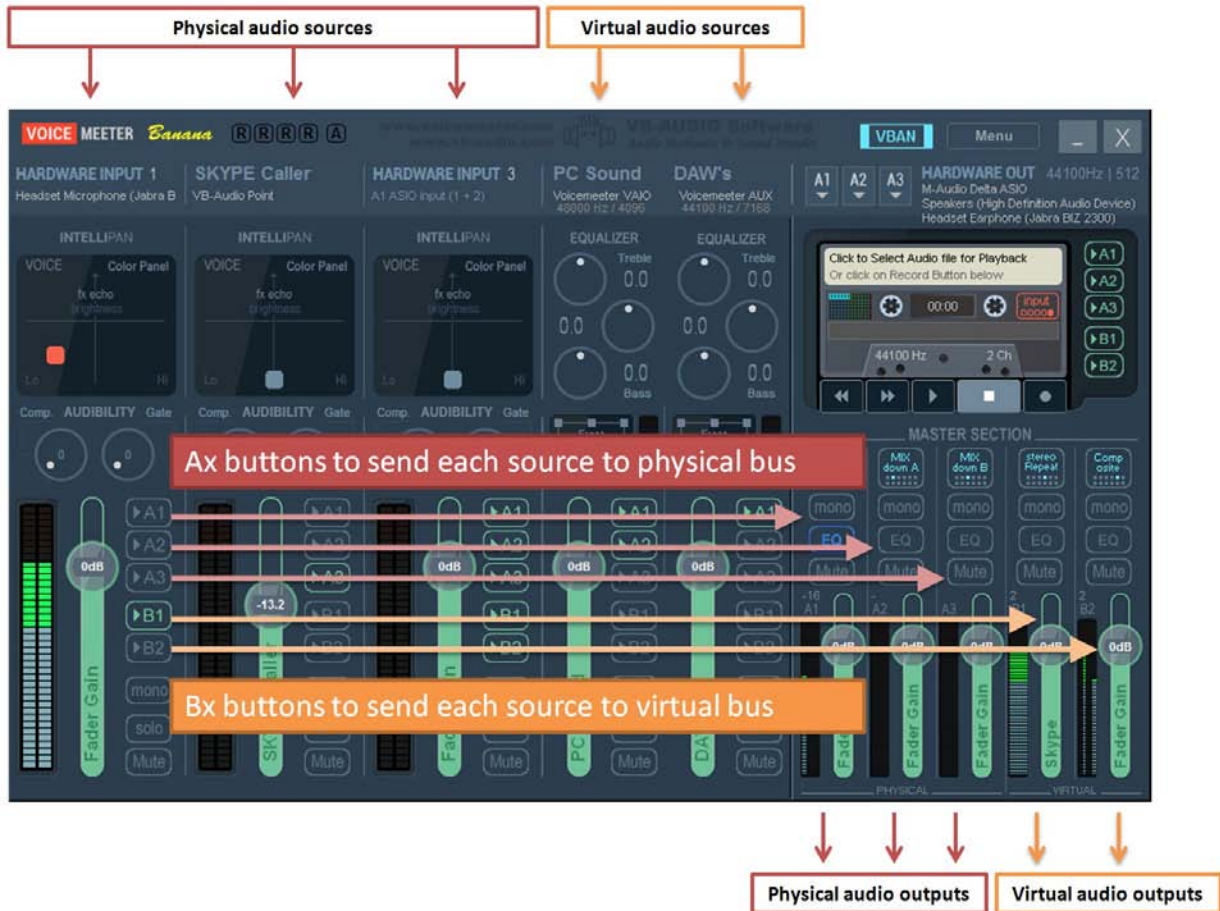

Master Section: Output BUS.

Each BUS offers different function to manage audio output behavior:

	<p>BUS Mode</p> <p>Mono / Cross</p> <p>Master EQ</p> <p>Mute</p> <p>Gain Slider</p>	<p>BUS Mode can change the contents or the channel organization of the BUS (see MODE next pages). Normal mode is just letting the 8 channels AS IS.</p> <p>MONO button allow to turn stereo to mono and if you click twice, cross the channel 1 and 2 of the BUS.</p> <p>Master EQ button allows to switch ON/OFF the Parametric EQ. Right click to open the Master EQ Dialog box.</p> <p>MUTE button allows to mute the BUS</p> <p>Finally, the Gain Slider allows to adjust the output volume of the BUS.</p>
--	---	---

BUS Master Parametric EQ.

Each BUS offers an EQ button to switch ON/OFF the Master 6 Cells Full Parametric EQ. Right Click on this EQ button to open the EQpro-G6 Dialog Box.



It provides 6 EQ Cells for the 8 possible channels of the BUS. The Channel Selector allows working on all channels in the same time or on a given channel only.

FLAT button will reset the Equalizer (according the channel selector)

A / B provides two different memories to define 2 different equalization settings and compare them just by switching to A or B. EQ settings are always done in current selected preset (A or B).

CH COPY: copy EQ settings of the current channel (to copy current channel equalization to another channel for example).

COPY ALL: copy EQ settings of all channels (to copy entire equalization to another BUS for example).

RIGHT CLICK on Gain / Q / Frequency Control to open a small Edit Box to enter value manually / precisely.

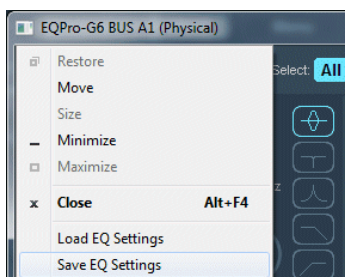

EQ Dialog Box System Menu offers two functions to simply LOAD / SAVE your EQ settings as a XML File (for the current BUS with its 8 channels).

Then it is possible copy the BUS EQ settings from a BUS to another... or/and share it with other users.

Right click on graph opens a menu to change dB Scale range

Special Routing Options on Output BUS.

Voicemeeter provides additional routing modes for all Busses in order to use the possible 8 output channels in different ways.



MIX DOWN

This button is made to make a stereo mix-down with 5.1 or 7.1 sound coming from DVD player on virtual input (strip #3). Left and right channels, Center, Sub and rear are combined to output on stereo speakers.

MIX DOWN A

Rear & side Speaker are mixed out of phase to simulate surround effect in stereo

MIX DOWN B

Rear & side Speaker are mixed in phase

STEREO REPEAT

This button is made to use possible 8 outputs channels with a stereo signal. This stereo signal is repeated to channel 3,4 / 5,6 and 7,8.

REPEAT mode also allows to use Master EQ as crossover for 2, 3 or 4 ways active speakers system (thanks to 6 LPF or HPF filters).

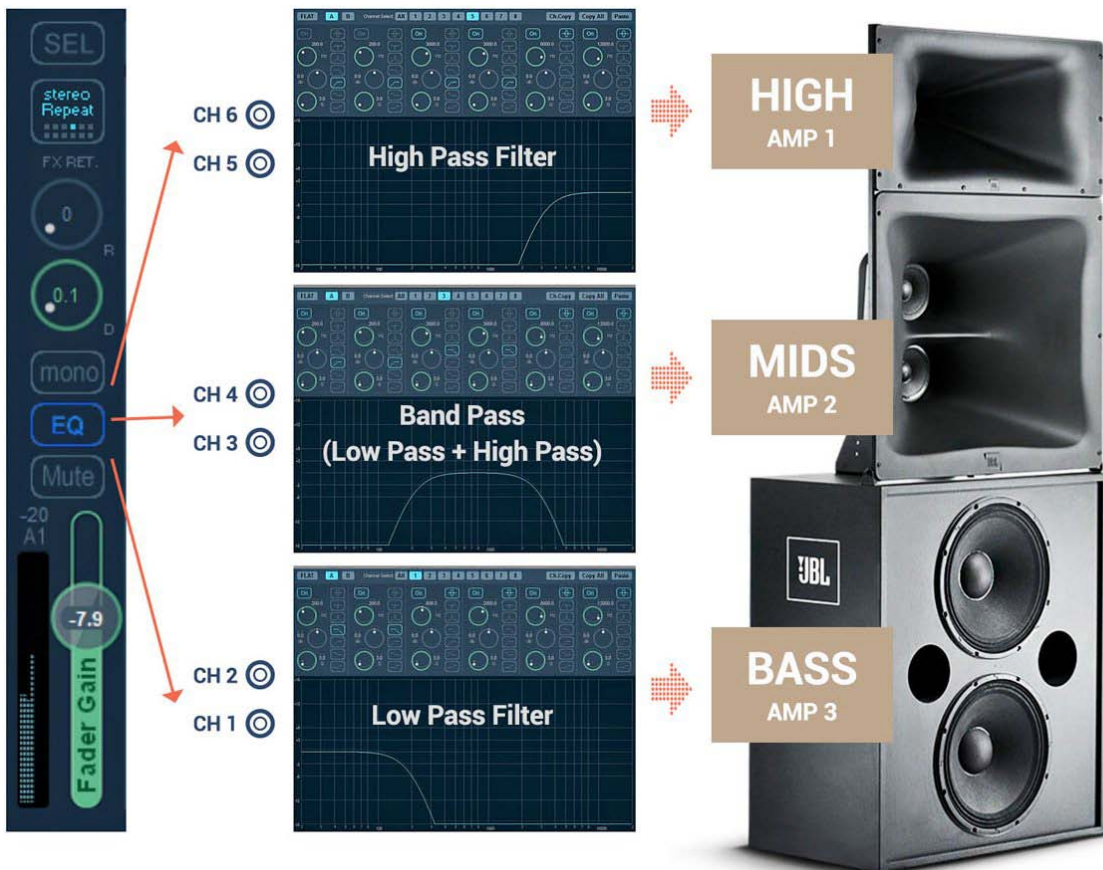

MIX DOWN A (Processing)

LEFT = FL + (70% FC) + SW + RL - SL
RIGHT = RL + (70% FC) + SW - RR + SR

MIX DOWN B (Processing)

LEFT = FL + (70% FC) + SW + RL + SL
RIGHT = RL + (70% FC) + SW + RR + SR

COMPOSITE

This last mode is made for audio post production. The 8 channels of the BUS can be composed by any pre-fader or post fader inputs (or default BUS channel): In the System Settings Dialog Box, user can define the Composite Patch.

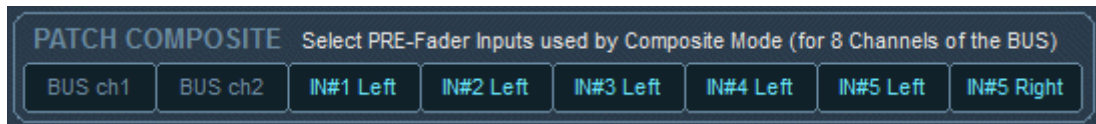

With composite signal, it's possible to record up to 8 channels composed by any Voicemeeter Inputs or with a DAW connected to Voicemeeter virtual ASIO, or with the integrated recorder. for example. It allows recording VOIP interview or conference and making post production process after, with up to 8 different tracks.



Since version 2.0.3.4, additional BUS modes are also present to up mix or extract specific channels:

For example

- To extract LFE channel and send it to sub devices (sub woofer, Buttkicker, Subpac...).
- To send 5.1 Rear channel to wireless speaker (Bluetooth).
- To send Center channel on specific speaker device.
- To use 2.1, 4.1, 5.1 or 7.1 PA system with stereo audio sources.

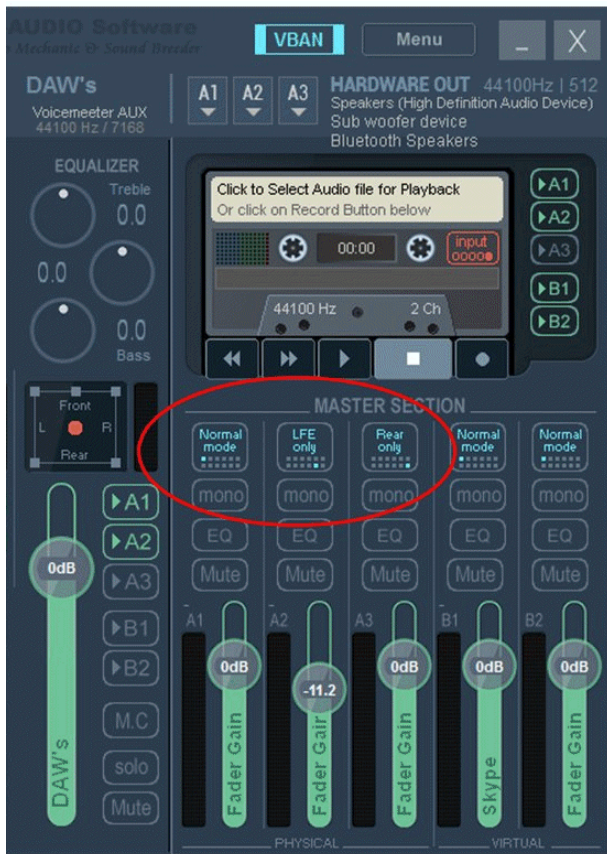

VB-Audio 8x8 Matrix - Voicemeeter APO Example -

	BUS A1	BUS A2	BUS A3	BUS B1	BUS B2				
In 1	1.00	0.00	0.59	0.44	0.00	0.00	0.11	0.13	Out 1
In 2	0.00	1.00	0.65	0.45	0.00	0.00	0.13	0.15	Out 2
In 3	0.00	0.00	1.00	0.00	0.00	0.00	0.00	0.00	Out 3
In 4	0.00	0.00	0.00	1.00	0.00	0.00	0.00	0.00	Out 4
In 5	0.00	0.00	0.00	0.00	1.00	0.00	0.00	0.00	Out 5
In 6	0.00	0.00	0.00	0.00	0.00	1.00	0.00	0.00	Out 6
In 7	0.22	0.21	0.00	0.00	0.00	0.00	1.00	0.00	Out 7
In 8	0.22	0.21	0.00	0.00	0.00	0.00	0.00	1.00	Out 8

Additional application:

It is also possible to get total control on 8 channels with a small application called 8x8 Gain Matrix, to redistribute all 8 channels of a 5.1 or 7.1 audio signal coming from your DVD player or Video Game.

This free application for Voicemeeter can be found on our forum here:

<https://forum.vb-audio.com/viewtopic.php?f=8&t=394>

All Voicemeeter BUS Mode (12):

Here below the list of 12 BUS Mode to manage the 8 channels of the BUS in 12 different ways.

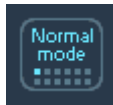

Normal Mode:

All channels are sent AS IS



MIX DOWN A

LEFT = FL + (70% FC) + SW + RL - SL
RIGHT = RL + (70% FC) + SW - RR + SR



MIX DOWN B

LEFT = FL + (70% FC) + SW + RL + SL
RIGHT = RL + (70% FC) + SW + RR + SR



STEREO REPEAT:

ch1 = FL, ch3 = FL, ch5 = FL, ch7 = FL
ch2 = FR, ch4 = FR, ch6 = FR, ch8 = FR



COMPOSITE MODE:

Contains pre fader inputs given by the COMPOSITE PATCH



UP MIX TV (create 7.1 from stereo)

FL = L, FC = 20%(L+R), RL = 70%(L-R), SL = 70%(L-R)
FR = R, SW=50%(L+R), RR = 70%(R-L), SR = 70%(R-L)



UP MIX 2.1

FL = L, FR = R, SW=50%(L+R).



UP MIX 4.1

FL = L, FR = R, SW=50%(L+R).
RL = L, RR = R



UP MIX 6.1

FL = L, FR = R, SW=50%(L+R).
RL = L, RR = R SL = L, SR = R



CENTER ONLY (extract Center)

LEFT = FC
RIGHT = FC



LFE ONLY (extract sub woofer)

LEFT = SW
RIGHT = SW

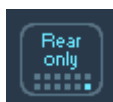

REAR ONLY (extract rear)

LEFT = RL
RIGHT = RR

ASIO Routing Capabilities.

With Voicemeeter 1.0.5.0 / 2.0.3.0 it is possible to route all physical inputs and busses to possibly 64 I/O of the ASIO Driver selected as output A1. It is the optimal way to use Voicemeeter with a professional audio board.

This is possible by selecting no device for physical input / physical bus. Then the system settings dialog box proposes to select input channels / or output channels for bus A2 and A3:

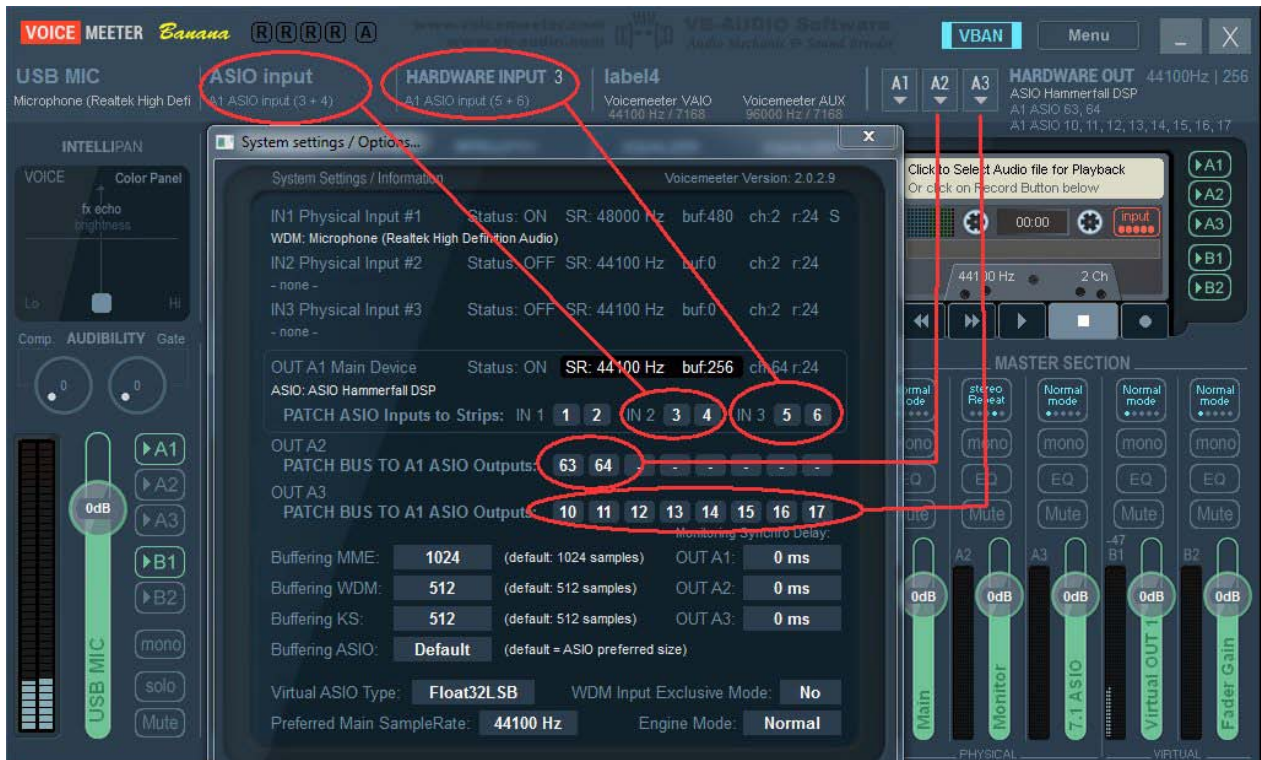

In this example:

- Physical Input #2 gets audio from ASIO input channels 3+4
- Physical input #3 gets audio from ASIO input channels 5+6
- BUS A1 automatically uses 8 first output channel of the ASIO board
- BUS A2 will send audio to ASIO output channels 63+64
- BUS A3 will send audio to ASIO output channel 10 to 17 (8 channels).

WARNING: BUS outputs are copied in the ASIO output channels in logical order A1, A2, A3. It means that A1 channels (1 to 8) could be replaced by A2 channels (if overlapping). For example if A2 is routed to channel 1+2, it will overwrite output A1 channel 1+2 (you won't hear the BUS A1 anymore, since it is replaced by A2).

Integrated Recorder

Voicemeeter Banana provides a simple player recorder to playback whatever WAV, AIFF, MP3, M4A, MP4, MOV, AVI, WMA, WMV files and to record easily everything in WAV, BWF, AIFF or even MP3 format:

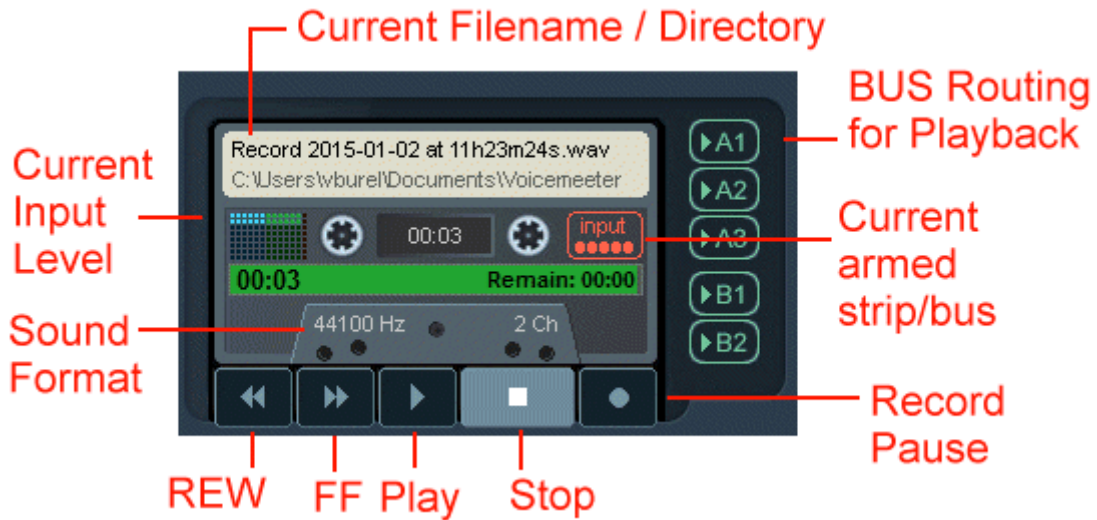

Click on cassette top to select audio file to playback. Click on progress bar to position playback cursor in audio file. You can click on RECORD at any moment. It will generate an audio file in your document / Voicemeeter folder with an automatic name with a prefix, the current date, start time and current file extension:

Example: **Record 2015-01-02 at 11h23m24s.wav**

Recording Options

Right Click on Tape Desk to get this recording option dialog box below:

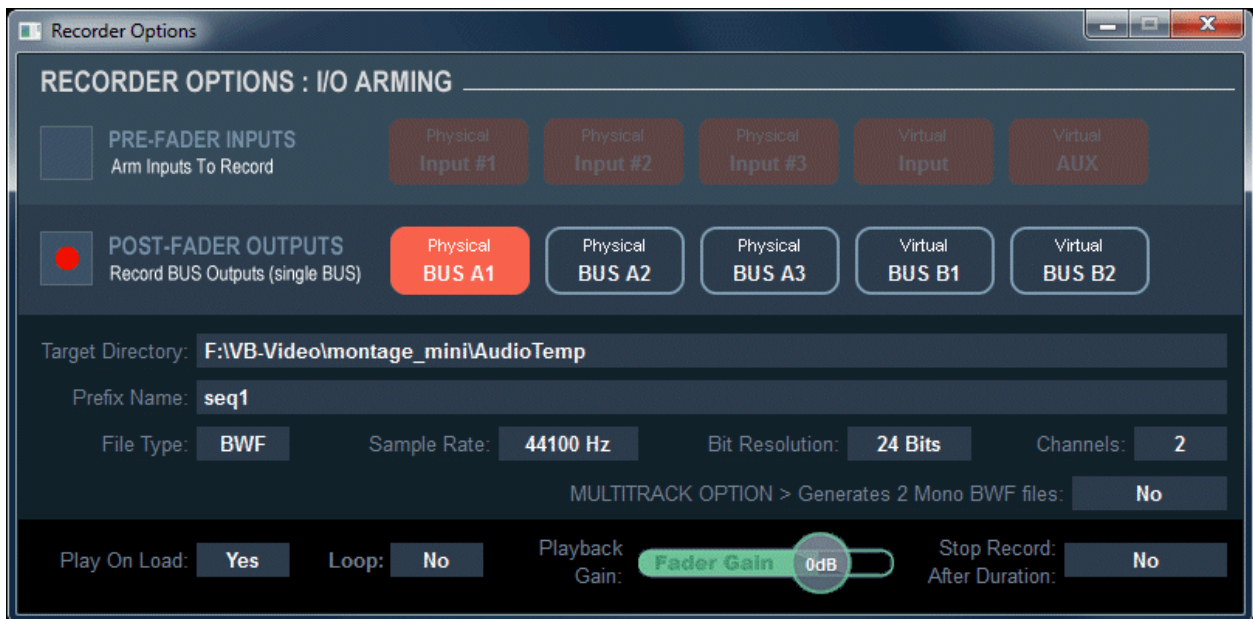

Per default recording options allows to record all pre-fader inputs to simply record everything coming in Voicemeeter But you can decide to record as well the output of a BUS.

PRE-FADER INPUTS

This option allows recording one or all inputs in stereo (mixed together), independently from the fader gain (and all fx, mute and solo states). This option is made to record original incoming audio signal, but all sources are mixed together with its original gain.

POST FADER OUTPUTS

This options is made to record the outputs of a BUS (from 2 to 8 channel) possible with COMPOSITE options. In other word this option allows to record what you hear on the selected BUS. Note that you can use a BUS not connected to an audio device to make a source assignation only for recording.

FILE OPTIONS:

The target directory and prefix of the filename can be defined by clicking on the related field and select new directory or enter new prefix (prefix is Record if nothing is defined).

FILE TYPE:

File type can de defined as WAV, BWF, AIFF or MP3 (32 to 320 kbps). MP3 can record stereo only while other format can support up to 8 channels (when recording a BUS).

File format, including sample rate, is defined independently than the format used by Voicemeeter. For example, the recording file format can be set in 48 kHz while Voicemeeter is running in 44100 Hz.

MULTITRACK OPTION:

If set to YES, the recording will also generate one file per track / channel. The file name will be suffixed by “_Track1”, “_Track2”, “_Track3”... according the number of channel defined for the file format.

PLAY ON LOAD:

This option will playback the file automatically just after selecting it.

LOOP:

This option will playback the file in loop, continuously.

PLAYBACK GAIN:

This slider control the gain of the audio file being played back.

STOP RECORD AFTER DURATION:

Let you define the time of a record session. It's a simple timer that will stop recording automatically after the given duration (set it to 00:00:00 to disable it). This is for example practical to record a movie or podcast with a known duration.

Menu for Extra functions

By clicking on “menu” area, user gets access to different functions:

The additional menu is there to provide additional functions:

- To Restart Audio Engine.
- To Automatically Restart Audio Engine if the Output A1 is disconnected.
- To Automatically Restart Audio Engine if any device is disconnected.
- To Release Audio File (used by the tape recorder).
- To load or save current settings in a given filename.
- To Load a particular settings file on startup, then you restart with the same settings anyway.
- To reset Voicemeeter complete settings.
- To set Voicemeeter in system tray.
- To run it on system startup.
- To show Voicemeeter on launch.
- To set Voicemeeter as always visible (window on top).
- To Lock main graphic user interface to prevent to change settings.
- To Run Macro Button or Streamer View on Voicemeeter launch. To run other applications installed with Voicemeeter.
- To hook key to control volumes on Voicemeeter with keyboard (Output A1 or A2 or Strip #1 level).
- To limit the remote gain (MIDI control) to 0dB (instead of +12 dB).
- To open different configuration dialog boxes (System settings, Recording options, M.I.D.I. mapping, VBAN Dialog Box).
- To shutdown the application

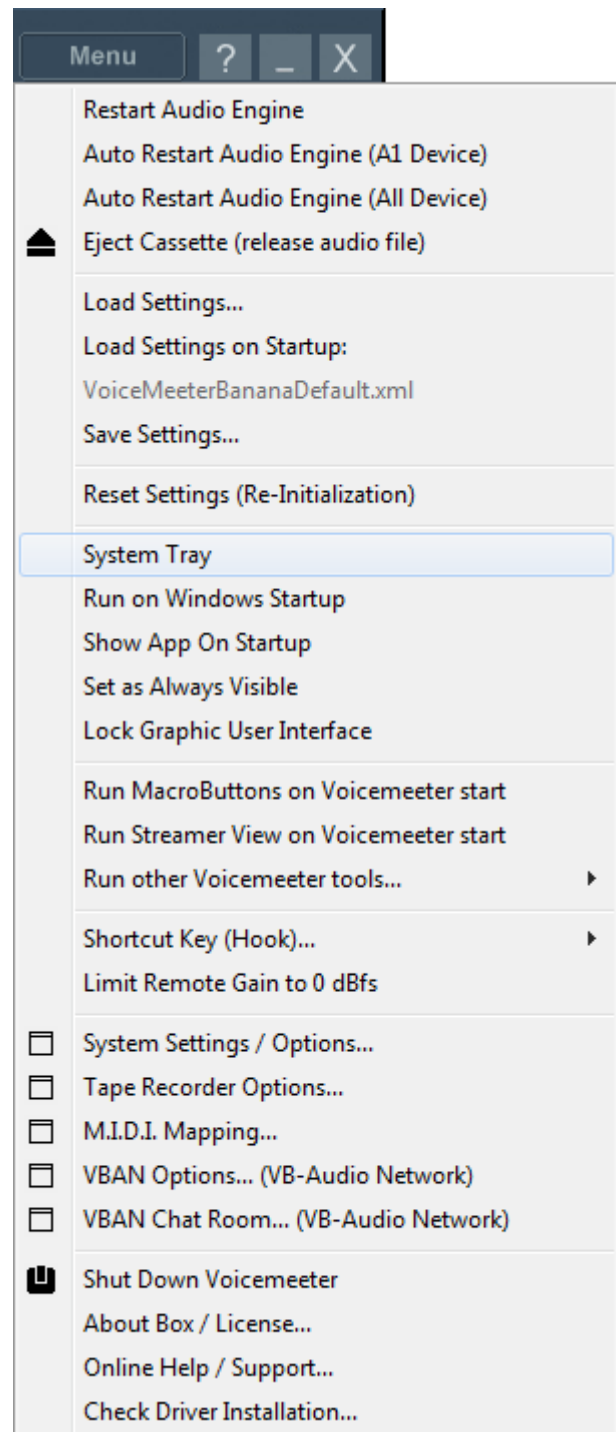

- The About Box will show you some link to get more information and donate on our webshop.
- System Settings Dialog Box allows to configure parameters related to audio device management..

- Tape Recorder Option Dialog Box is made to configure the audio file recording process.
- M.I.D.I. Mapping Dialog Box allows connecting a M.I.D.I. controller to Voicemeeter.
- VBAN Dialog Box will help you to configure the VB-Audio Network functions, to send/receive audio stream to/from any computer of your local network.
- Click on “Check Driver Installation” to run the VBDeviceCheck.exe program and get a detailed diagnostic on VB-Audio Driver Installation. This program is executed on each Voicemeeter Launch to check that there has been no corruption due to WIN10 Update. More information on our forum: <https://forum.vb-audio.com/viewtopic.php?f=6&t=442>

Other Voicemeeter Tools & Accessories:

To demonstrate Voicemeeter Remote API audio callback mechanism, Voicemeeter is installed with two audio plug-ins applications (8x8 Gain Matrix & Graphiq EQ). A standalone application called VBAN2MIDI to convert physical MIDI stream into VBAN protocol is also installed.



8x8 Gain Matrix:

This simple application provides a single 8x8 gain matrix applicable on the selected BUS.

This can be helpful to re-distribute audio channels into different multi channel speaker systems.

This application has been developed with the gain matrix example provided in the Voicemeeter Remote API SDK:

<https://forum.vb-audio.com/viewtopic.php?f=8&t=346>

15 Bands graphic EQ :

This simple application provides a 15 bands graphic EQ applicable on the selected BUS.

This can be helpful to adjust the sound of your P.A. System (stereo only).



VBAN2MIDI :

Standalone application to send VBAN-MIDI stream from a MIDI input device or send MIDI message to physical MIDI Output from an incoming VBAN-MIDI Stream.

Warning: 2 applications cannot use the same UDP port in the same time.

VBAN

VB-Audio Network

VBAN: VB-Audio Network

VBAN Protocol, based on a simple UDP protocol, has been designed for real-time transport of digital audio stream in IP-based network environments. It provides an easy ways to send / receive audio to / from any computers on a **local network**.

VBAN-Talkie and VBAN-Receptor are applications for mobile device (iOs / Android) also implementing the VBAN Protocol to send and receive audio stream from or to Voicemeeter.

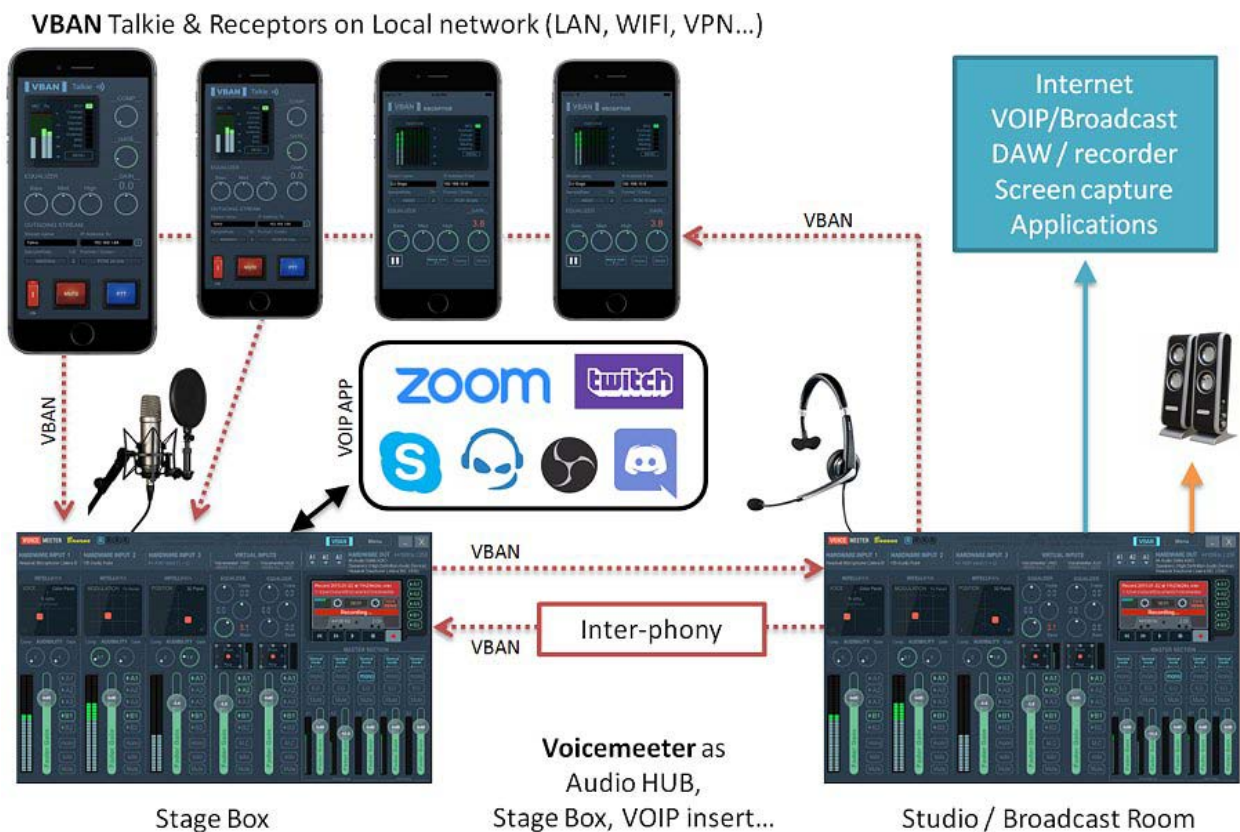

VBAN Protocol is free to use to be implemented everywhere. The PCM native Audio protocol, the VBAN-TEXT protocol and the VBAN-MIDI protocol are public. You can get specification document on our support page: <https://vb-audio.com/Services/support.htm> and find numerous projects using it on GitHub.

Open VBAN Configuration dialog box:

Click on VBAN icon to open the configuration dialog box below and configure your incoming stream (the audio stream from other computer you want to hear) and your outgoing stream (the audio stream you want to send to other computers).



VoiceMeeter Banana & Potato offer to listen 8x streams (on any input) and to send 8x streams to 8x different computers or mobile devices (audio source is given by selected BUS output).

A VBAN Stream in VoiceMeeter can be set in any standard samplerate from 11025 Hz to 96 kHz in 16 or 24 bits resolution with 1 to 8 channels (mono sound to 7.1). It allows transporting high quality audio in native PCM format on your local network.

It is possible to broadcast an audio stream by using the 255 IP Address (on wire network only! WIFI AP are usually not broadcast capable). For example giving 192.168.1.255 as destination address will send stream to all computers of the network 192.168.1.xxx

VBAN can also transport serial and text to remote VoiceMeeter with MIDI message or specific request script. That's why VoiceMeeter also offers a Serial and an ASCII incoming stream.

For VBAN identification / VBAN-Chat service, it is also possible to define a USER NAME and a color.

VBAN outgoing stream section now includes a VBAN-MIDI stream, getting MIDI stream from the MIDI-Mapping. It allows sending all incoming MIDI or a particular MIDI source (including MIDI output for MIDI Feedback) through the network. Then it is possible to use a MIDI Controller on the network (by using VBAN2MIDI application) with both VBAN MIDI-IN and VBAN-MIDI Out

VBAN Services / Identification

New services have been implemented to simplify user experience, especially to validate connections. The 'i' right after the IP-Address field is highlighted when the connection is validated by a VBAN-Ping hand check. Right click on 'i' to get further information about distant VBAN unit.

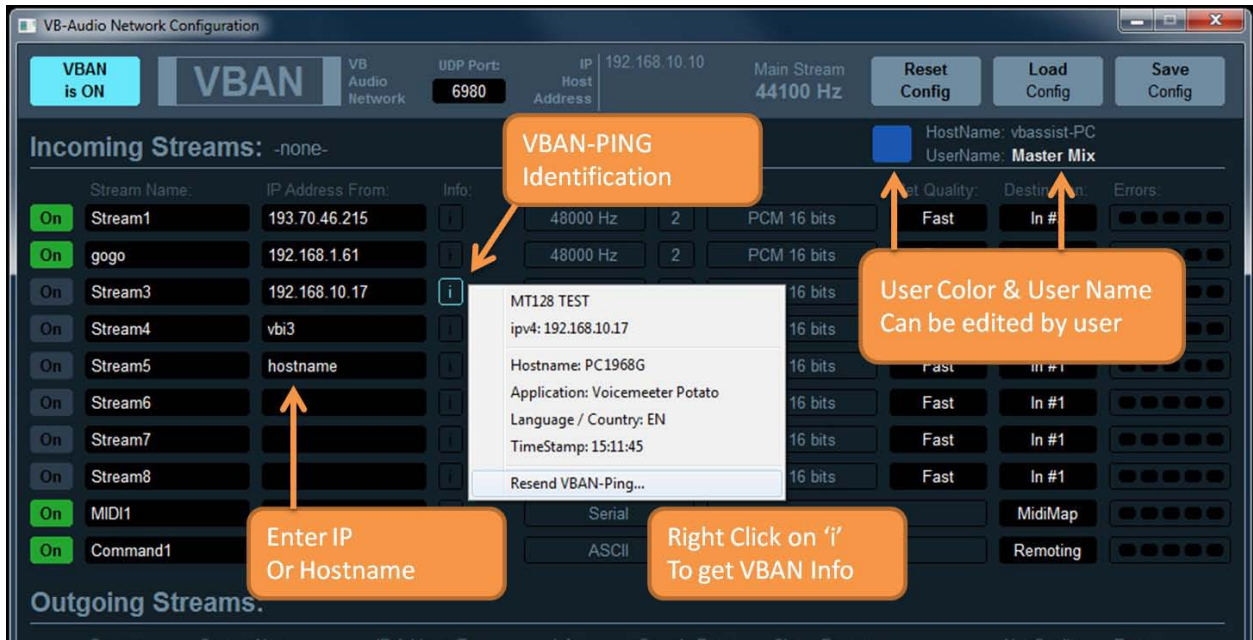

IP-Address field also accept hostname (instead of IP-Address).

Right click on VBAN icon to open VBAN-Chat dialog box

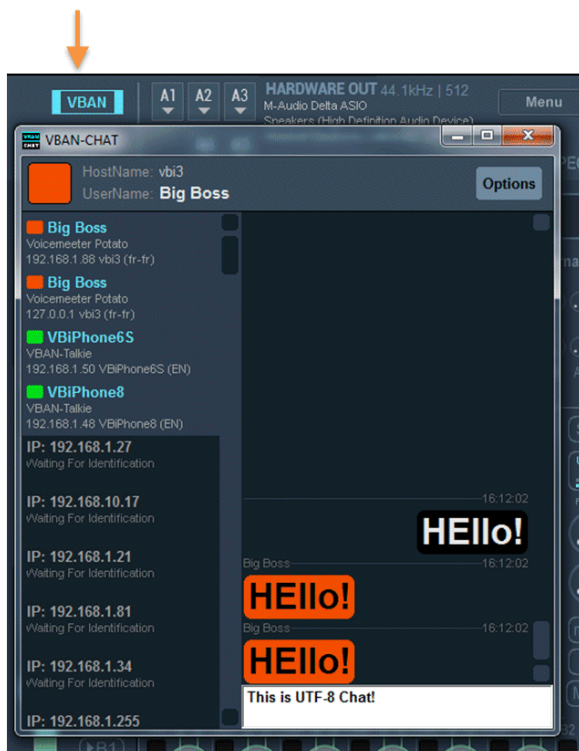

The VBAN Chat service is implementing basic CHAT functions to talk between VBAN-units.

VBAN-Chat is list all IP-Address used by the VBAN configuration dialog box and all IP-Address identified by a VBAN-Ping. Then you may see all connected unit around.

When sending a TEXT message, all connected VBAN-unit will receive it and automatically display the VBAN-Chat Dialog box.

OPTION menu allows changing some display option and font size. It is also possible to send <nudge> and <alert>.

Configure VBAN Audio Stream

We can configure VBAN stream just by clicking on black fields in the dialog box. An edit box or popup menu will appear to let you define parameters. UDP port used by VBAN is 6980 per default. An Audio Stream is defined by its NAME, IP-ADDRESS FROM (and UDP port). To receive an audio stream these 3 parameters must be the same on receiver.

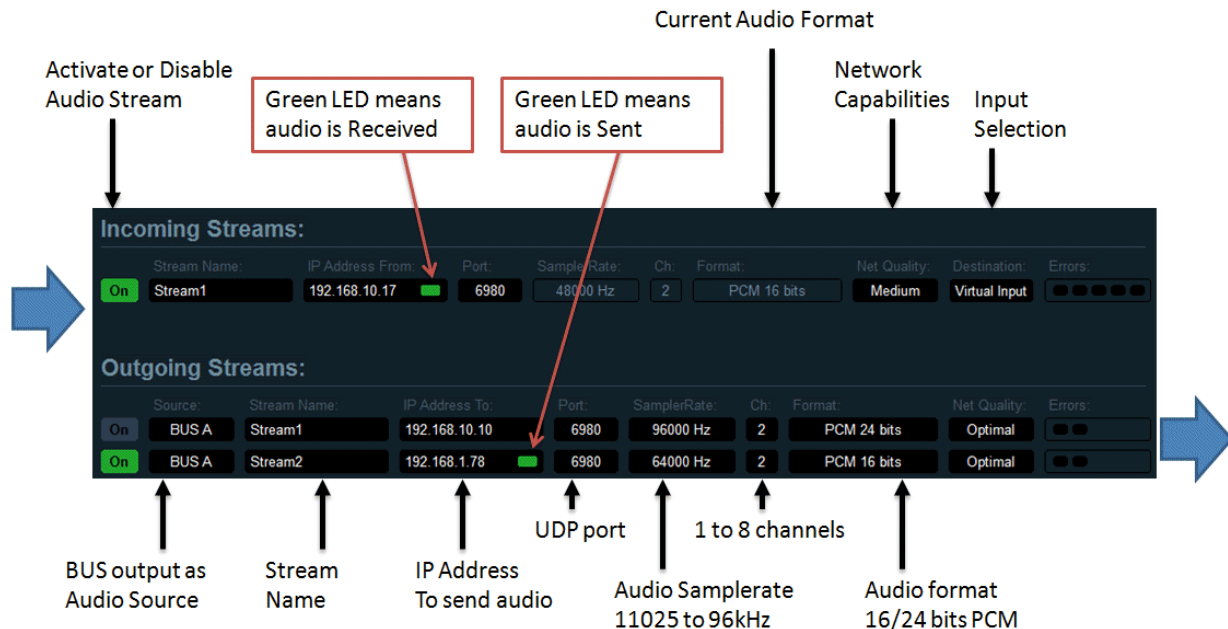

Send audio stream to other computer / device:

To select an outgoing stream, define stream name and destination IP-address of the target computer of your local network and switch it ON. The audio stream being sent will come from the selected source (BUS A or BUS B)

Receive audio stream from other computer / device:

On incoming stream, RIGHT CLICK on "Stream name" area or "IP Address from" area to get the list of current detected incoming stream and select it directly. Otherwise it is possible to edit Stream Name and IP-Address manually. Switch ON the Stream to receive audio on virtual input strip.

NETWORK QUALITY: This parameter, more useful on incoming stream, allows tweaking the audio stream stability in case of bad or busy network. FAST means the network is able to transport audio without delay or error, SLOW is made for busy network, where audio packet can be delayed or lost more often than usual.

ERROR LED: shown on the right are blinking red in case of reception errors:

- 1- Overload: we received too much packets (audio stream comes too fast)
- 2- Corrupt: we received corrupted packets
- 3- Disorder: we received older packets
- 4- Missing: we missed packets (lost)
- 5- Underrun: not enough packets received (audio stream comes too slow or is stopped).

REM: If too much overload & underrun errors are appearing, you may change the Network Quality parameter to FAST or more SLOW settings.

Additional VBAN-MIDI or Command stream.

Incoming streams section offers 2 other specific VBAN Streams to receive MIDI or TEXT. Opposite to Audio Stream, MIDI or TXT streams do not need an "IP-Address From" and can manage any message coming from anywhere. This is typically done to allow remoting Voicemeeter from several points in the same time. Note the MIDI Stream feeds Voicemeeter MIDI Mapping and is also received by MacroButton.

Stream Name:	IP Address From:	Port:	SamplerRate:	Ch:	Format:	Net Quality:	Destination:	Errors:
On Stream1	192.168.10.17	6980	48000 Hz	2	PCM 16 bits	Fast	Virtual In #1	●●●●●●
On Stream1	192.168.10.11	6980	48000 Hz	2	PCM 16 bits	Fast	In #3	●●●●●●
On Stream3	192.168.10.10	6980	48000 Hz	2	PCM 16 bits	Fast	In #3	●●●●●●
On Room 3	192.168.10.52	6980	48000 Hz	2	PCM 16 bits	Fast	In #2	●●●●●●
On Stream5	192.168.10.53	6980	48000 Hz	2	PCM 16 bits	Fast	In #2	●●●●●●
On Stream6		6980	48000 Hz	2	PCM 16 bits	Fast	In #1	●●●●●●
On Stream7		6980	48000 Hz	2	PCM 16 bits	Fast	In #1	●●●●●●
On Stream8		6980	48000 Hz	2	PCM 16 bits	Fast	In #1	●●●●●●
On MIDI1		6980	115200 bps Serial		90 00 00		MidiMap	●●●●●●
On Command1		6980	256000 bps UTF8		strip(0),mute=1,strip(1),mute=1,strip(2),mute=		Remoting	●●●●●●

No address = any Last received TXT message Last received MIDI message

VBAN MIDI messages and TEXT commands can be sent by MacroButton (see next pages).

VBAN MIDI messages can also be sent by VBAN2MIDI application (installed with Voicemeeter).

VBAN2MIDI application.

This simple standalone application allow converting a physical MIDI input into a VBAN outgoing stream (LEFT Side) and the opposite: from a VBAN MIDI Stream, send incoming data to a physical MIDI output (Right Side).

VBAN2MIDI-Converter (Version 1.002)

M.I.D.I. Input Device: Analog Experience - The Player M.I.D.I. Output Device: Delta AP MIDI

MIDI input → VBAN → VBAN → MIDI output

OUTGOING VBAN STREAM INCOMING VBAN STREAM

Stream Name:	IP-Address To:	UDP Port:	Stream Name:	IP-Address From:
On MIDI1	192.168.10.255	6980	On MIDI1	any

80 35 17 MTC: 00 : 00 : 00 . 00 80 35 17

This application can also be used to connect a MIDI controller on second PC through the network with Voicemeeter MIDI mapping as explained in the next page...

1- Connect your controller on PC1 with VBAN2MIDI to manage outgoing and incoming VBAN MIDI STREAM.

On the left side, the outgoing stream: MIDI Controller out -> MIDI Input Device -> VBAN2MIDI -> Target IP Address On the right side, the incoming stream (MIDI feedback) from any IP Address -> VBAN2MIDI -> MIDI output device -> MIDI Controller In.

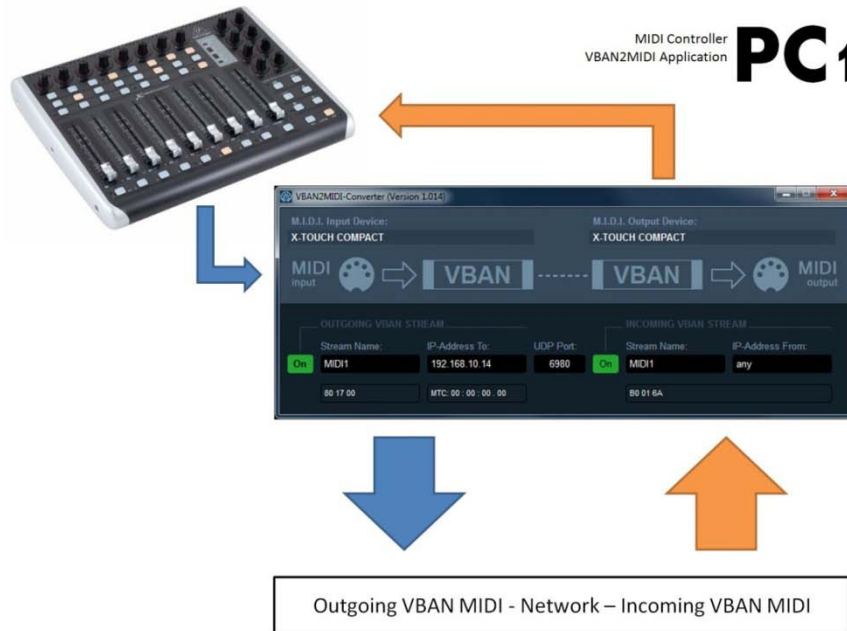

2- The MIDI mapping always take in account the incoming VBAN-MIDI stream activated in the VBAN -Dialog BOX (check the name is MIDI1 on transmitter and on receptor side).

You can see incoming MIDI message in VBAN Dialog box and go in MIDI mapping to learn on desired control. "VBAN MIDI Input" in MIDI mapping dialog box is an info box related to VBAN MIDI outgoing stream and should be labeled "VBAN MIDI Output" instead.

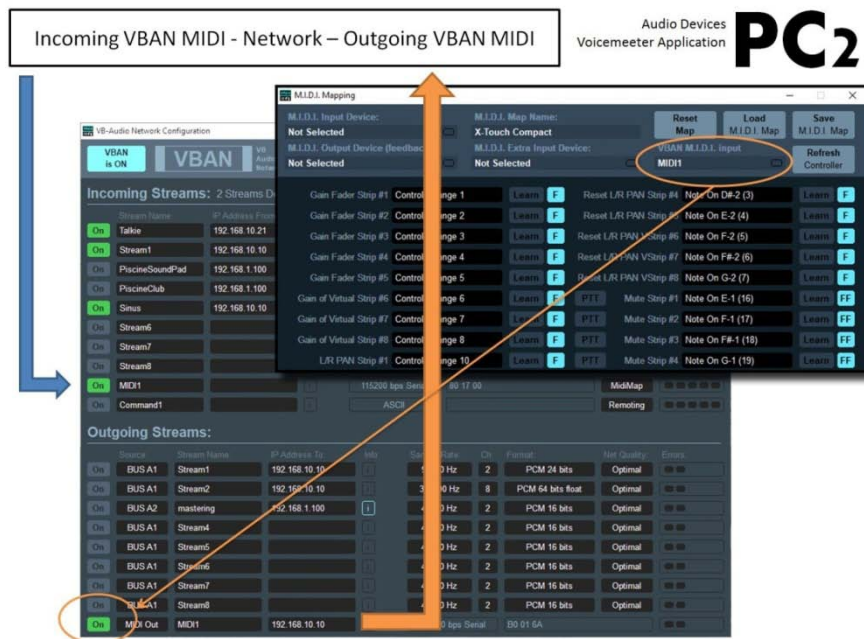

MACRO-Buttons

Voicemeeter Remote API

MACRO Buttons

Delivered and installed with Voicemeeter, MACRO BUTTONS Application allows creating programmable buttons to control Voicemeeter parameters. It is displaying several (4 to 80) push or 2 positions buttons with a title / sub title and the possibility to assign a keyboard shortcut / mouse / Game pad / MIDI message or even Audio Trigger.



MACRO Button is an independent application using Voicemeeter Remote API. It is also demonstrating the capability to develop a client application to control Voicemeeter by program. This is made to allow creating any new applications, with custom graphic user interface, to make automation, to make VCA or Auto Ducking process or even to process audio directly inside Voicemeeter thanks to the different possible audio interfaces and API's.

MACRO BUTTON application has been designed for Voicemeeter users, to make custom action, or group of actions on the different Voicemeeter controls and parameters:

- To mute a strip or a bus.
- To change the gain on one or several strips / busses.
- To change or toggle BUS assignations on one or several strips.

It is also possible to combine different requests to create a complex action on Voicemeeter. For example a PUSH TO TALK or AUTO DUCKING function could set the MUSIC Gain to -10db and mute other talker in the same time.

- To change voices color/audibility to make special announces.
- To Restart Audio Engine.
- To save or load a complete configuration file.

On Voicemeeter BANANA version, it is also possible to:

- Make voice FX by changing Modulation and Color Panel.
- Launch Sound by the integrated audio player
- Make special correction with the bus parametric EQ
- Remote all VBAN functions

Finally MACRO Buttons also provides system functions to:

- Send Keyboard Event to System Queue (to remote other applications).
- Execute any program (with possibly a command line).
- Send M.I.D.I. Message to 2x possible devices.
- Send VBAN-MIDI / VBAN TXT requests.

Configuring MACRO Buttons

Right click on the button to open the dialog box below and configure your button. It is basically possible to define 3 scripts of request(s); one for initial condition(s) (sent on startup), one sent when the button is pushed and one when the button is released.

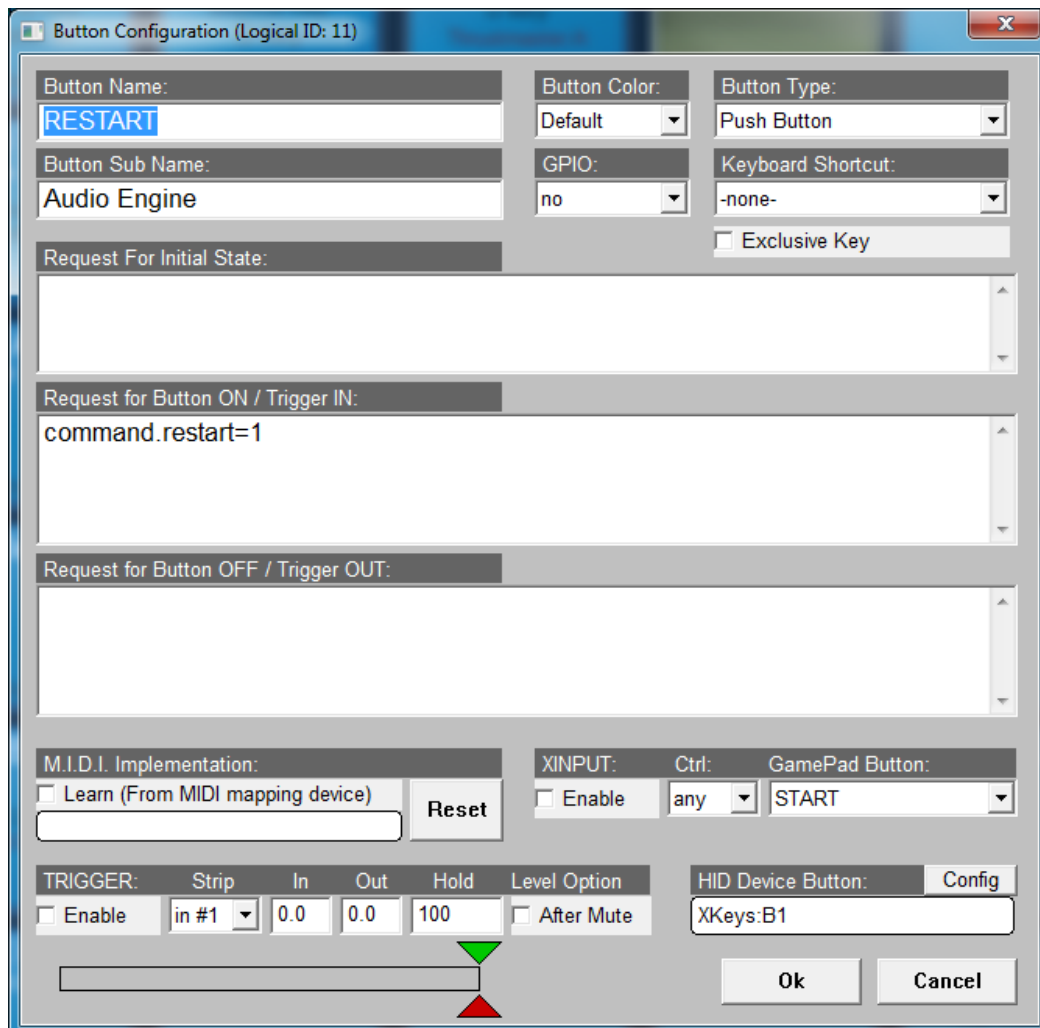

Button type can be PUSH or 2 POSITIONS. Keyboard shortcut dropdown list proposes different Key and Mouse buttons combinations. Button color proposes 9 different buttons backgrounds.

M.I.D.I. Implementation allows assigning one M.I.D.I. Event to the button as well. The M.I.D.I. codes are coming from the M.I.D.I. device selected in the Voicemeter M.I.D.I. Mapping Dialog Box and possibly incoming VBAN MIDI stream. Check LEARN box to get message from M.I.D.I. Device. Click on RESET to remove the M.I.D.I. Code.

TRIGGER will allow handling the button according 2 thresholds on a selected input strip level. IN threshold (green cursor) will push the button when level goes over... OUT threshold (red cursor) will release the button when the level goes under. HOLD time define a minimal time to let gate opened.

XINPUT section will let you use up to 4 game pad to control a button.

HID Device Button allows connecting directly to any HID device (see details on next pages).

Button Color

The parameter called “Button Color” allows selecting 8 other background colors for the button.



Voicemeeter Remote Requests

Request is composed by a structured name (related to voicemeeter control or parameter) and a value or a string behind.

Voicemeeter Banana Control Name for MacroButtons Script & Remote API Functions

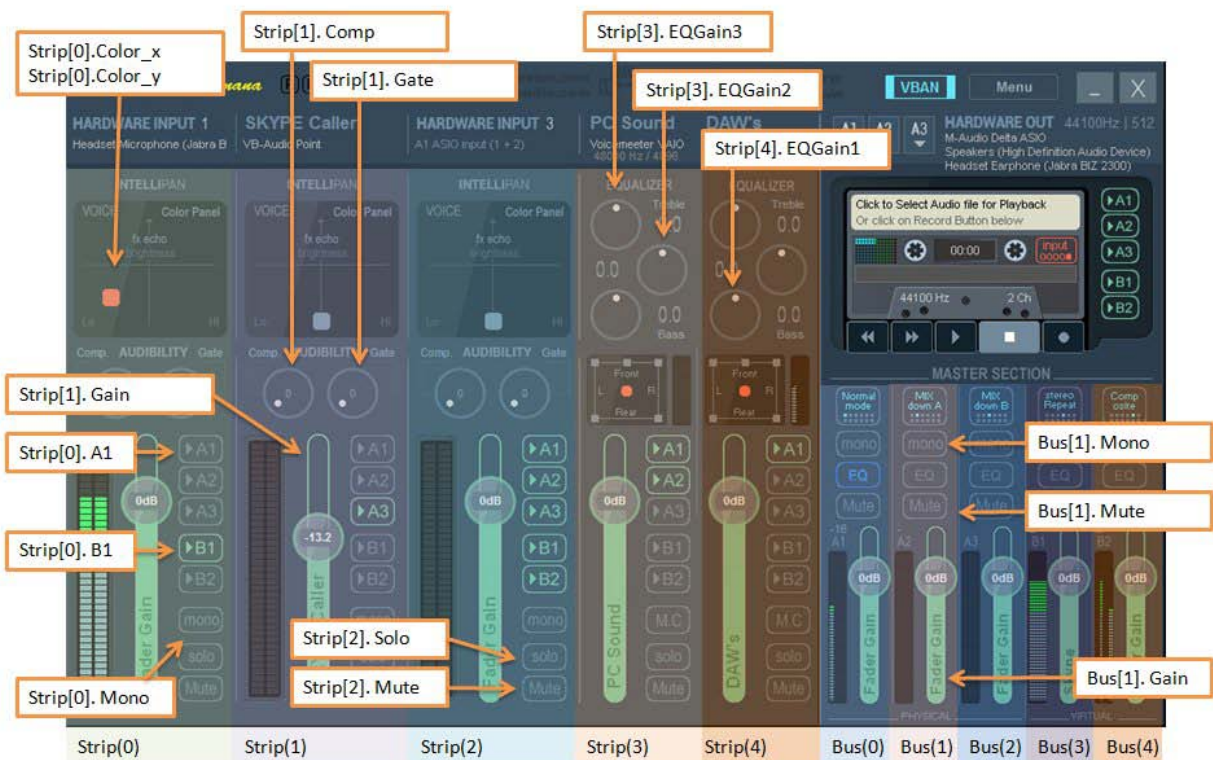

www.voicemeeter.com

Request example with numbers:

```
Strip(0).mute=1;           // MUTE ON the first strip of Voicemeeter
Strip(0).mute=0;         // UNMUTE the first strip of Voicemeeter
Strip(0).mute +=1;      // Change the current state of the Mute button

Bus(0).mono=1;          // Set the first BUS in Mono mode

Bus(0).gain=-10.0;      // set BUS Slider Gain to -10.0 dB
Strip(0).gain=+6.0;     // set Strip Slider Gain to +6.0 dB

Bus(0).gain +=3.0;      // Add 3 dB to current BUS Slider Gain
Strip(0).gain -=3;      // Remove 3 dB to current Strip Slider Gain
```

```
Command.Restart = 1; // request to restart audio engine
```

Request example with string:

```
Command.Load= "C:\My Documents\VMConfig1.xml"; //load Config File in Voicemeeter
```

Input Strip Parameters:

Strip index is a zero based index related to Voicemeeter version (3 strips on Voicemeeter, 5 on Voicemeeter Banana)

Strip functions/parameters

Parameter Name	Value Range	Remark	Ver.
Strip[i].Mono	0 (off) or 1 (on)	Mono Button	1
Strip[i].Mute	0 (off) or 1 (on)	Mute Button	1
Strip[i].Solo	0 (off) or 1 (on)	Solo Button	1
Strip[i].MC	0 (off) or 1 (on)	Mute Center Button	1
Strip[i].Gain	-60 to +12 dB	Gain slider	1
Strip[i].GainLayer[j]	-60 to +12 dB	Gain slider for a bus	3
Strip[i].Pan_x	-0.5 to +0.5		1
Strip[i].Pan_y	0 to 1.0	-0.5 to 0.5 for 5.1 pan pot	1
Strip[i].Color_x	-0.5 to +0.5	Physical Strip Only	1
Strip[i].Color_y	0 to 1.0	Physical Strip Only	1
Strip[i].fx_x	-0.5 to +0.5	Physical Strip Only	2
Strip[i].fx_y	0 to 1.0	Physical Strip Only	2
Strip[i].Audibility	0 to 10	Voicemeeter 1 only	1
Strip[i].Comp	0 to 10		2
Strip[i].Gate	0 to 10		2
Strip[i].Karaoke	0,1, 2, 3,4	OFF or one of 4 karaoke algorithm	2
Strip[i].Limit	-40 to +12 dB		2
Strip[i].EQGain1	-12 to +12 db	Virtual Strip Only	1
Strip[i].EQGain2	-12 to +12 db	Virtual Strip Only	1
Strip[i].EQGain3	-12 to +12 db	Virtual Strip Only	1
Strip[i].Label	String	Strip Label	1
Strip[i].A1	0 (off) or 1 (on)	Out BUS Assignment	1
Strip[i].A2	0 (off) or 1 (on)	Out BUS Assignment	2
Strip[i].A3	0 (off) or 1 (on)	Out BUS Assignment	2
Strip[i].A4	0 (off) or 1 (on)	Out BUS Assignment	3
Strip[i].A5	0 (off) or 1 (on)	Out BUS Assignment	3
Strip[i].B1	0 (off) or 1 (on)	Out BUS Assignment	1
Strip[i].B2	0 (off) or 1 (on)	Out BUS Assignment	2
Strip[i].B3	0 (off) or 1 (on)	Out BUS Assignment	3
Strip[i].FadeTo	String	(dBTarget, msTime);	1
Strip[i].FadeBy	String	(dB relativechange, msTime);	1
Strip[i].Reverb	0 to 10	Send Level To Reverb	3
Strip[i].Delay	0 to 10	Send Level To Delay	3
Strip[i].Fx1	0 to 10	Send Level To External Fx1	3
Strip[i].Fx2	0 to 10	Send Level To External Fx2	3
Strip[i].PostReverb	0 (off) or 1 (on)	Post Reverb button	3
Strip[i].PostDelay	0 (off) or 1 (on)	Post Delay button	3
Strip[i].PostFx1	0 (off) or 1 (on)	Post Fx1 button	3
Strip[i].PostFx2	0 (off) or 1 (on)	Post Fx2 button	3

i= strip zero based index. J= Bus zero based index.

Strip Audio Devices (physical strip only)

Parameter Name	Value Range	Remark	Ver.
Strip[i].device.wdm	Device Name	String	1
Strip[i].device.ks	Device Name	String	1
Strip[i].device.mme	Device Name	String	1
Strip[i].device.asio	Device Name	String	1

i= strip zero based index.

BUS Parameters:

Bus index is a zero based index related to Voicemeeter version (2 busses on Voicemeeter, 5 on Voicemeeter Banana)

Bus functions/parameters

Parameter Name	Value Range	Remark	Ver.
Bus[i].Mono	0 (off), 1 (mono) 2 (stereo reverse)	Mono Button	1
Bus[i].Mute	0 (off) or 1 (on)	Mute Button	1
Bus[i].EQ.on	0 (off) or 1 (on)	EQ Button	2
Bus[i].EQ.AB	0 (A) or 1 (B)	EQ Memory Slot	2
Bus[i].Gain	-60 to +12 db	Gain slider	1
Bus[i].Label	String	Strip Label	1
Bus[i].mode.normal	0 (off) or 1 (on)	BUS Mode	1
Bus[i].mode.Amix	0 (off) or 1 (on)	BUS Mode	1
Bus[i].mode.Bmix	0 (off) or 1 (on)	BUS Mode	2
Bus[i].mode.Repeat	0 (off) or 1 (on)	BUS Mode	1
Bus[i].mode.Composite	0 (off) or 1 (on)	BUS Mode	1
Bus[i].mode.TVMix	0 (off) or 1 (on)	BUS Mode	2
Bus[i].mode.UpMix21	0 (off) or 1 (on)	BUS Mode	2
Bus[i].mode.UpMix41	0 (off) or 1 (on)	BUS Mode	2
Bus[i].mode.UpMix61	0 (off) or 1 (on)	BUS Mode	2
Bus[i].mode.CenterOnly	0 (off) or 1 (on)	BUS Mode	2
Bus[i].mode.LFEOnly	0 (off) or 1 (on)	BUS Mode	2
Bus[i].mode.RearOnly	0 (off) or 1 (on)	BUS Mode	2
Bus[i].EQ.channel[j].cell[k].on	0 (off) or 1 (on)	EQ cell On/Off	2
Bus[i].EQ.channel[j].cell[k].type	0 to 6	EQ type of the Cell	2
Bus[i].EQ.channel[j].cell[k].f	20 to 20.000 Hz	Cell Frequency	2
Bus[i].EQ.channel[j].cell[k].gain	-12 to +12 db	Cell Gain	2
Bus[i].EQ.channel[j].cell[k].q	1 to 100	Cell Quality	2
Bus[i].FadeTo	String	(dBTarget, msTime);	1
Bus[i].FadeBy	String	(dB change,msTime);	1
Bus[i].Sel	0 (off) or 1 (on)	BUS SEL Button	3
Bus[i].ReturnReverb	0 to 10	Reverb return	3
Bus[i].ReturnDelay	0 to 10	Delay return	3
Bus[i].ReturnFx1	0 to 10	FX1 return	3
Bus[i].ReturnFx2	0 to 10	FX2 return	3

i= bus zero based index, j=channel zero based index (0 to 7), k=cell zero based index (0 to 5).

BUS Audio Devices (physical bus only)

Parameter Name	Value Range	Remark	Ver.
Bus[i].device.wdm	Device Name	Write only	1

Bus[i].device.ks	Device Name	Write only	1
Bus[i].device.mme	Device Name	Write only	1
Bus[i].device.asio	Device Name	Write only	1

i= bus zero based index.

Special functions to make timed fade in/out:

Strip().FadeTo or Bus().FadeTo function allow to set the gain slider with a progressive fade by settings a dB value and a time to reach it (time in ms between 0 and 120000). The parameter is a string since it needs 2 parameters, example:

```
Strip(0).FadeTo= (-10.0, 500); //will set the slider to -10 dB in 500ms
Strip(0).FadeTo= (-20.0, 2000); //will set the slider to -10 dB in 2 seconds
Bus(0).FadeTo= (0.0, 1500); //will set the bus slider to 0 dB in 1,5 seconds
```

Same remark is valid for the instruction FadeBy

System Settings Option:

Voicemeeter remote API also allows changing different configuration parameters: Patch and System Settings.

Patch Options

Parameter Name	Value Range	Remark	Ver.
patch.asio[i]	0 to ASIO input	ASIO Patch	1
patch.OutA2[i]	0 to ASIO output channel	ASIO Patch A2 Bus	2
patch.OutA3[i]	0 to ASIO output channel	ASIO Patch A3 Bus	2
Patch.composite[j]	0 to 22 (1 = first channel)	0 = default BUS	2
Patch.insert[k]	0 (off) or 1 (on)	Virtual ASIO insert	2
Patch.PostFaderComposite	0 (PRE) or 1 (POST)	COMPOSITE Mode	2
Patch.PostFxInsert	0 (PRE) or 1 (POST)	Virtual INSERT Point	2

i= input channel zero based index (for physical strips only – 2 channels per strip).

j= composite channel zero based index (0 to 7) COMPOSITE mode is maed of 8 channels.

k= input channel zero based index (0 to 21).

System Settings

Parameter Name	Value Range	Remark	Ver.
Option.sr	44.1, 48, 88.2, 96, 176.4 or 192 kHz	Preferred samplerate	1
Option.ASIOSr	0: default ASIO Samplerate 1: preferred samplerate.	For ASIO driver connected on output A1	1
Option.delay[i]	0 to 500ms max	BUS output delay	1
Option.buffer.mme	128 to 2048	MME buffer size	1
Option.buffer.wdm	128 to 2048	WDM buffer size	1
Option.buffer.ks	128 to 2048	KS buffer size	1
Option.buffer.asio	128 to 2048	ASIO Buffer Size	1
Option.mode.exclusif	0 (off) or 1 (on)	WDM input exclusive	1
Option.mode.swift	0 (off) or 1 (on)	WDM swift mode	1

i= output zero based index (for physical bus only)

Tape Recorder Options:

Voicemeeter remote API allows controlling the integrated recorder in Voicemeeter Banana.

Recorder Options

Parameter Name	Value Range	Remark	Ver.
recorder.stop	0 (off) or 1 (on)	STOP	2
recorder.play	0 (off) or 1 (on)	PLAY	2
recorder.replay	1	PLAY FROM 0	2
recorder.ff	0 (off) or 1 (on)	Fast Forward button	2
recorder.rew	0 (off) or 1 (on)	Reward	2
Recorder.goto	00:00:00 (hh:mm:ss)	position in seconds	2
recorder.A1	0 (off) or 1 (on)	Out BUS Assigation	2
recorder.A2	0 (off) or 1 (on)	Out BUS Assigation	2
recorder.A3	0 (off) or 1 (on)	Out BUS Assigation	2
recorder.A4	0 (off) or 1 (on)	Out BUS Assigation	3
recorder.A5	0 (off) or 1 (on)	Out BUS Assigation	3
recorder.B1	0 (off) or 1 (on)	Out BUS Assigation	2
recorder.B2	0 (off) or 1 (on)	Out BUS Assigation	2
recorder.B3	0 (off) or 1 (on)	Out BUS Assigation	3
recorder.record	0 (off) or 1 (on)	REC	2
Recorder.load	File name to playback	Write only	2
Recorder.samplerate			2
Recorder.ArmStrip(i)	Arming Input Status		2
Recorder.ArmBus(i)	Arming BUS Status		2
Recorder.mode.recbus	0 (off) or 1 (on)	0 to record inputs	2
Recorder.mode.PlayOnLoad	0 (off) or 1 (on)		2
Recorder.mode.Loop	0 (off) or 1 (on)	Loop Mode	2
Recorder.mode.MultiTrack	0 (off) or 1 (on)	MultiTrack mode	2
Recorder.bitResolution	8, 16, 24, 32	32 is float type	2
Recorder.Channel	1 - 8		2
Recorder.kbps	For mp3 format		2
Recorder.FileType	1 = WAV, 2 = AIFF, 3=BWF 100 = MP3		2
Recorder.gain	-60 to +12 db	Playback Gain	2

i= zero based index (0 to 8).

Special Commands:

Special Commands are not made to change parameter but to make an action. Here some command presented in the menu (write only of course).

Command Name	Value Range	Remark	Ver.
Command.Shutdown	1	Shutdown Voicemeeter	1
Command.Show	1	Show Voicemeeter	1
Command.Restart	1	Restart Audio Engine	1
Command.Eject	1	Eject Cassette	1
Command.Reset	1	Reset All configuration	1
Command.Save	String	Complete filename (xml)	1
Command.Load	String	Complete filename (xml)	1
Command.Lock	0 or 1	(Un)Lock GUI (Menu option)	1
Command.Button[i].State	0 or 1	Change Macro Button State	1
Command.Button[i].StateOnly	0 or 1	Change Button State only	1

Command.Button[i].Trigger	0 or 1	Change Trigger Enable State	1
Command.Button[i].Color	0 to 8	Change the Button Color	1
Command.DialogShow.VBANCHAT	0 or 1	Show VBAN-Chat Dialog	1
Command.SaveBUSEQ[j]	String	Complete filename (xml)	2
Command.LoadBUSEQ[j]	String	Complete filename (xml)	2

i= MacroButton ID (zero based index). j = BUS index (zero based index).

Typical use:

```
Command.Restart = 1; // request to restart audio engine
```

```
Command.Load= "C:\My Documents\VMConfig1.xml"; // load Config File in Voicemeeter.
```

NOTE: command requests are prior to other requests. It means other type of request could not be processed if in the same request packet than a command request. For example Shutdown Request, simply closes the program without processing next request. LOAD request reset all possible previous or next requests present in the same packet.

EJECT cassette function (also present in the menu) is made to release audio file and let other applications access to it.

Button command for button interactions

It is also possible to change the state of one or several other buttons by using the following commands, to change the state only of a button, or emulate PUSH / RELEASE function.

```
Button(5).State = 1; //PUSH the button ID 5
Button(5).State = 0; //RELEASE the button ID 5

Button(5).StateOnly = 1; //set the button ID 5 in pushed state
```

This instruction below works only in INIT Script:

```
Button.State = 0; //change the state of the current button
```

To change the Trigger option on a given button you may use the following instruction

```
Button(5).Trigger = 1; //Enable Audio Trigger on button ID 5
Button(5).Trigger = 0; //Disable Audio Trigger on button ID 5
```

Wait command to create sequence of requests

With the September 2019 version, the Wait command allows to introduce timing pause between requests and finally create a sequence of requests.

```
Strip(0).gain=-12.0; // will be send on button push
Wait(2000);
Strip(0).gain=0.0; // will be sent 2 seconds later
Wait(1000); // wait one second again
Strip(0).FadeTo= (-10.0, 1000);
Wait(1000);
Strip(0).FadeTo= (0.0, 1000);
```

Load Button map

With the Mars 2020 version, the Load command allows to use a button to load another Button Map (MacroButtons config file) previously stored with the SAVE function in the system menu of the MacroButtons application.

```
Load("filename"); //load button map in MacroButtons
```

VBAN Options:

Voicemeeter remote API allows controlling VBAN features and all parameters presented on the VBAN dialog Box. Then it is possible to remote VBAN functions to route/send/receive audio to/from different computers.

VBAN Options

Parameter Name	Value Range	Remark	Ver.
<code>vban.Enable</code>	0 (off) or 1 (on)	VBAN functions	1
<code>vban.instream[i].on</code>	0 (off) or 1 (on)	Stream On/Off	1
<code>vban.instream[i].name</code>	String	Stream Name	1
<code>vban.instream[i].ip</code>	String	IP Address from	1
<code>vban.instream[i].port</code>	16 bit range	PORT (Ethernet)	1
<code>vban.instream[i].sr</code>	11025 to 96 kHz	Read only	1
<code>vban.instream[i].channel</code>	1 to 8	Read only	1
<code>vban.instream[i].bit</code>	VBAN data type	Read only	1
<code>vban.instream[i].quality</code>	0 to 4	0 = Optimal	1
<code>vban.instream[i].route</code>	0 to 8	Strip Selector	1
<code>vban.outstream[i].on</code>	0 (off) or 1 (on)	Stream On/Off	1
<code>vban.outstream[i].name</code>	String	Stream Name	1
<code>vban.outstream[i].ip</code>	String	IP Address To	1
<code>vban.outstream[i].port</code>	16 bit range	PORT (Ethernet)	1
<code>vban.outstream[i].sr</code>	11025 to 96 kHz		1
<code>vban.outstream[i].channel</code>	1 to 8		1
<code>vban.outstream[i].bit</code>	VBAN data type	1 = 16 bits PCM	1
<code>vban.outstream[i].quality</code>	0 to 4	0 = Optimal	1
<code>vban.outstream[i].route</code>	0 to 8	BUS selector	1

i= zero based index (0 to 7).

Like in the VBAN Dialog Box the following parameters change are producing an Audio Engine Restart:

- `vban.Enable`
- `vban.instream[i].port`
- `vban.instream[i].quality`
- `vban.outstream[i].quality`

VBAN SampleRate:

11025, 16000, 22050, 24000, 32000, 44100, 48000, 64000, 88200, 96000 Hz

VBAN Quality:

0 (Optimal), 1 (Fast), 2 (Medium), 3 (Slow), 4 (very slow). Quality parameter is conditioning the size of internal stack (also the latency) to cope to possible network instability and then increase the stream stability if required. **Optimal** quality considers the network is able to transmit packet in real time (with a good regularity), while **very slow** quality considers the network can have timing problem and unexpected waiting cycles. This parameter is more useful on receiver side while the transmitter is supposed to work always in OPTIMAL mode.

VBAN Bit Resolution / data format:

Allowed Format are 1 (16 bit PCM) or 2 (24 bits PCM).

AUTO Ducking (Trigger):

With the TRIGGER, it is possible to make auto ducking and control any parameters or function (REC button for example) according an input level.

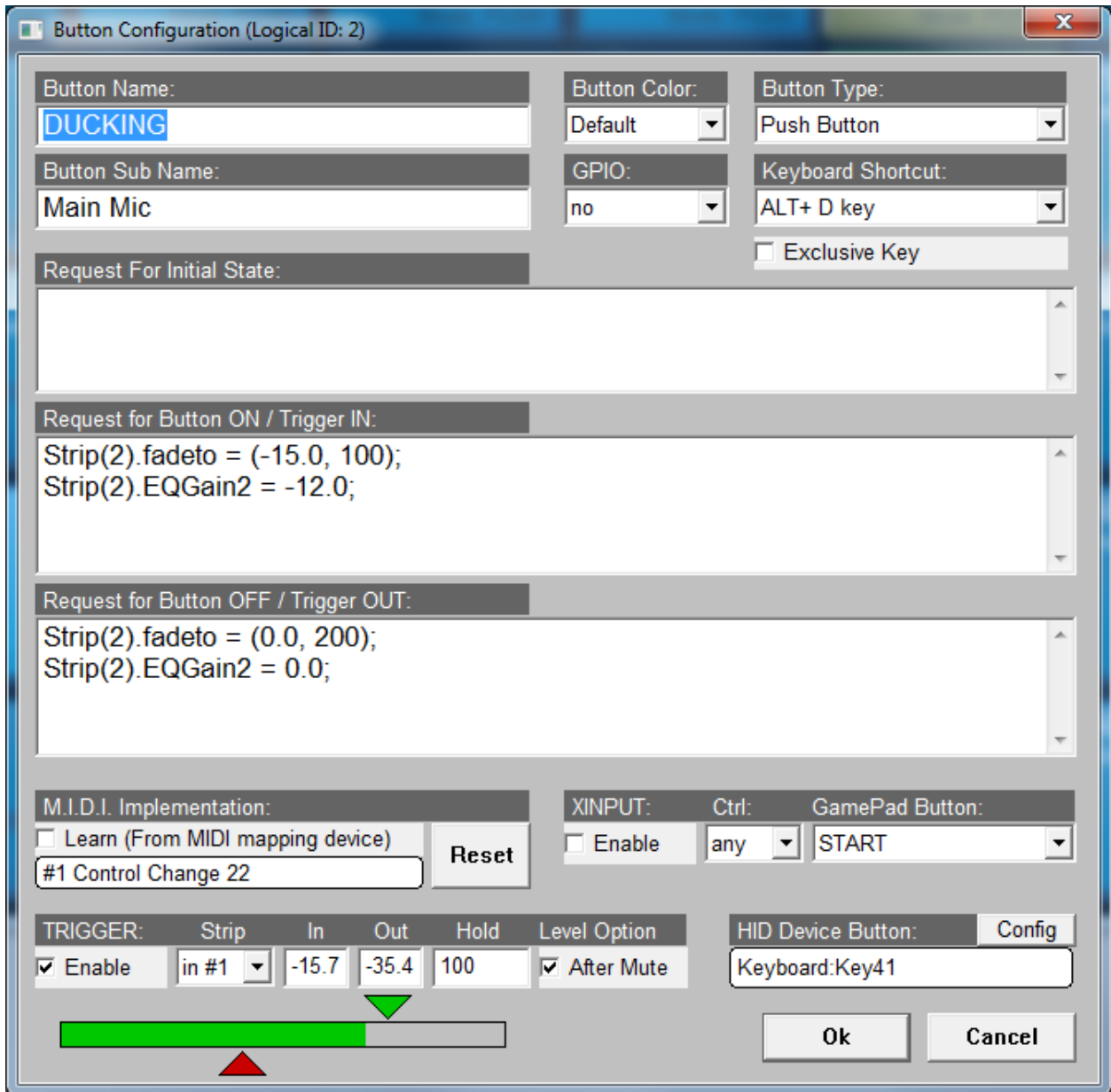

In this example, the hardware input in#1 is the Microphone and the Strip(3) is the virtual input of Voicemeeter Banana (used to get music). This virtual input will be faded to -15 dB and medium EQ by -12 dB when the user will talk in the microphone, more precisely, when the microphone level will go over -13 dB (to be adjusted according microphone level).

“Level Option” allows user to mute his microphone on Voicemeeter to disable the trigger. Otherwise trigger is working even if the microphone is muted on Voicemeeter.

Green cursor shows the “IN” threshold (level to go over to generate a trigger in). Red cursor shows the “OUT” threshold (level to go below to generate trigger out).

GPIO:

The GPIO combo box allows to select one of the 16 GPI (general purpose input) provided by an extra USB module called GPI8-USB.



The DB9 connector allows connecting 8 simple electric switches, foot pedal or anything able to create an electric contact. It is possible to connect a second DB9 connector for the Line 9-16.



HOW TO BUY THIS GPI8-USB MODULE?

Check our website www.vb-audio.com to get more information.

System Functions (to send command to Windows):

In Macro Buttons application, some instructions are made for operating system to send Keyboard Event or run “command line” like program. These special instructions, following a “function” like syntax, can be inserted in the request script, with instructions for Voicemeeter.

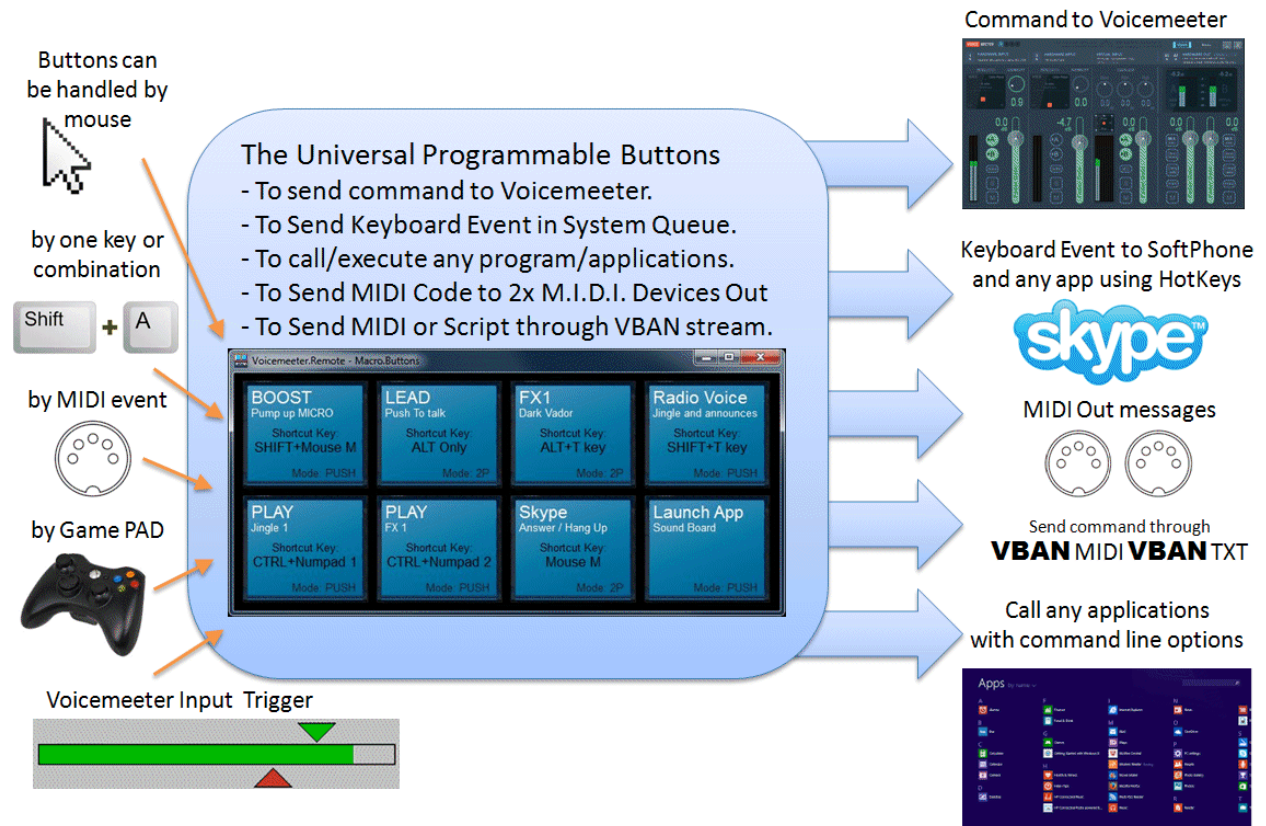

System Command

function Name	Value Type	Remark	Ver.
<code>System.KeyDown (szKey)</code>	String		1
<code>System.KeyUp (szKey)</code>	String		1
<code>System.KeyPress (szKey)</code>	String	Send Key Down + Key Up	1
<code>System.Mouse ("Action")</code>	String	LBUTTONDOWN, LBUTTONUP, RBUTTONDOWN, RBUTTONUP, MBUTTONDOWN, MBUTTONUP	1
Example : <code>System.Mouse ("LBUTTONDOWN") ;</code>			
<code>System.Execute (exe, dir, arg)</code>	Strings		1

These commands are not sent to Voicemeeter but directly to operating system.

System Execute

This function works like a “CreateProcess” or ShellExecute under windows and allow to start any application with a command line argument.

```
System.Execute (szprogram, szworkdir, szcommand) ;
```

Example to open a web page with the internet explorer:

List of Key Name:

Regular Keys	NUM PAD	Special Key	FUNCTION
0 to 9	NP0 to NP9	BROWSERBACK	SHIFT
A to Z	NPMUL	BROWSERFORWARD	CTRL
BACK	NPADD	BROWSERREFRESH	ALT
TAB	NPDOT	BROWSERSTOP	
RETURN	NPSUB	BROWSERSEARCH	LWIN
ESC	NPDEC	BROWSERFAV	RWIN
SPACE	NPDIV	BROWSERHOME	LSHIFT
PAGEUP	NUMLOCK	VOLUMEMUTE	RSHIFT
PAGEDOWN	SCROLLLOCK	VOLUMEDOWN	LCTRL
END	CAPSLOCK	VOLUMEUP	RCTRL
HOME	PRINTSCREEN	MEDIANEXT	LMENU
LEFT	PAUSE	MEDIAPREV	RMENU
UP	CLEAR	MEDIASTOP	
RIGHT	SELECT	MEDIAPAUSE	F1 to F12
DOWN	PRINT	LAUNCHMAIL	F13 to F24
INSERT	PRINTSCREEN	MEDIASELECT	
DELETE	HELP	LAUNCHAPP1	
	APP	LAUNCHAPP2	
	EXECUTE	PLAY	

Send M.I.D.I. Message

In Macro Buttons 1.0.1.1 it is possible to select 2x MIDI output devices, defining out1 and out2 MIDI device. Then it is possible to send MIDI messages to these devices by a simple script.

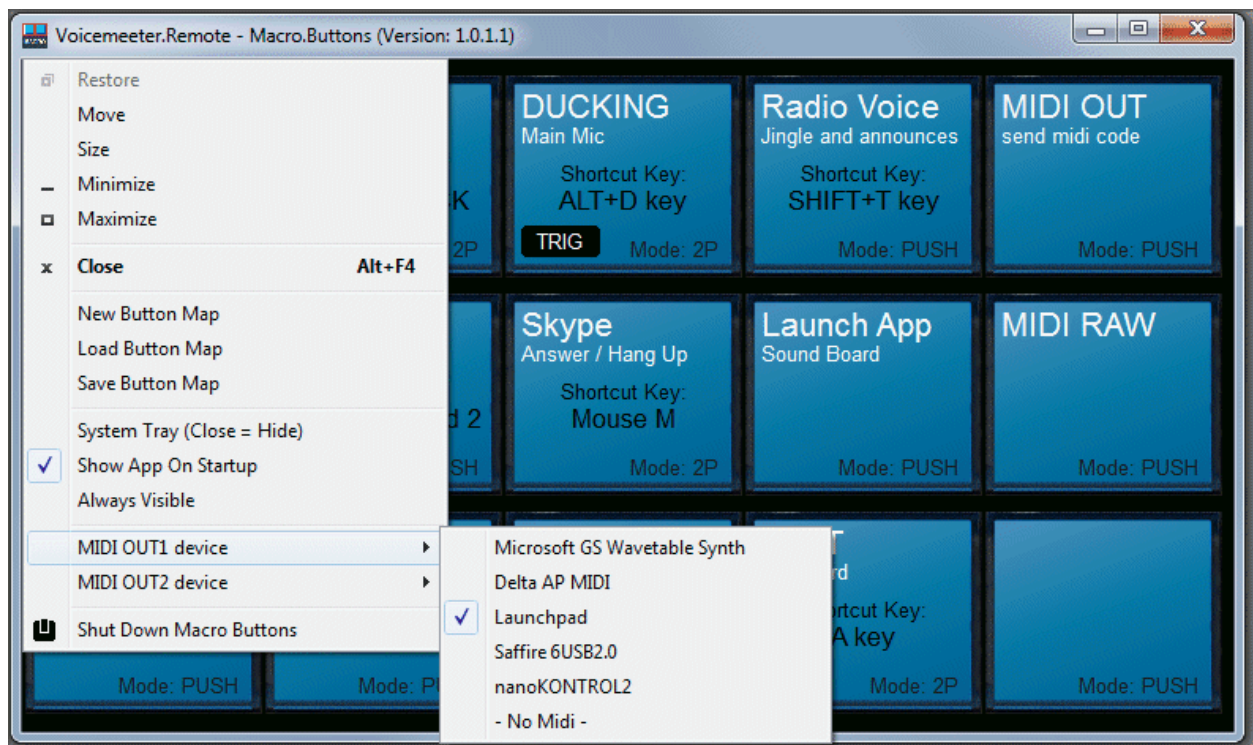

4x request types are implemented (channel 1 to 16):

```
System.SendMidi("out1", "note-on", channel, note, velocity);
System.SendMidi("out1", "note-off", channel, note, velocity);
System.SendMidi("out1", "ctrl-change", channel, ctrl, value);
System.SendMidi("out1", "prg-change", channel, nPrg);
```

There is also a RAW DATA function to send any M.I.D.I. Message (including sys-ex).

```
System.SendMidi("out1", "data", aa, bb, cc, ee, ff, gg, ...);
```

(In this function only, values are in HEXA-Decimal: 00 to FF)

Note that values are in decimal (0 to 127) in MIDI function except for data message, value are in hexa decimal (16 based 0 to F / e.g. 90 = 9 x 16 + 0 = 144)

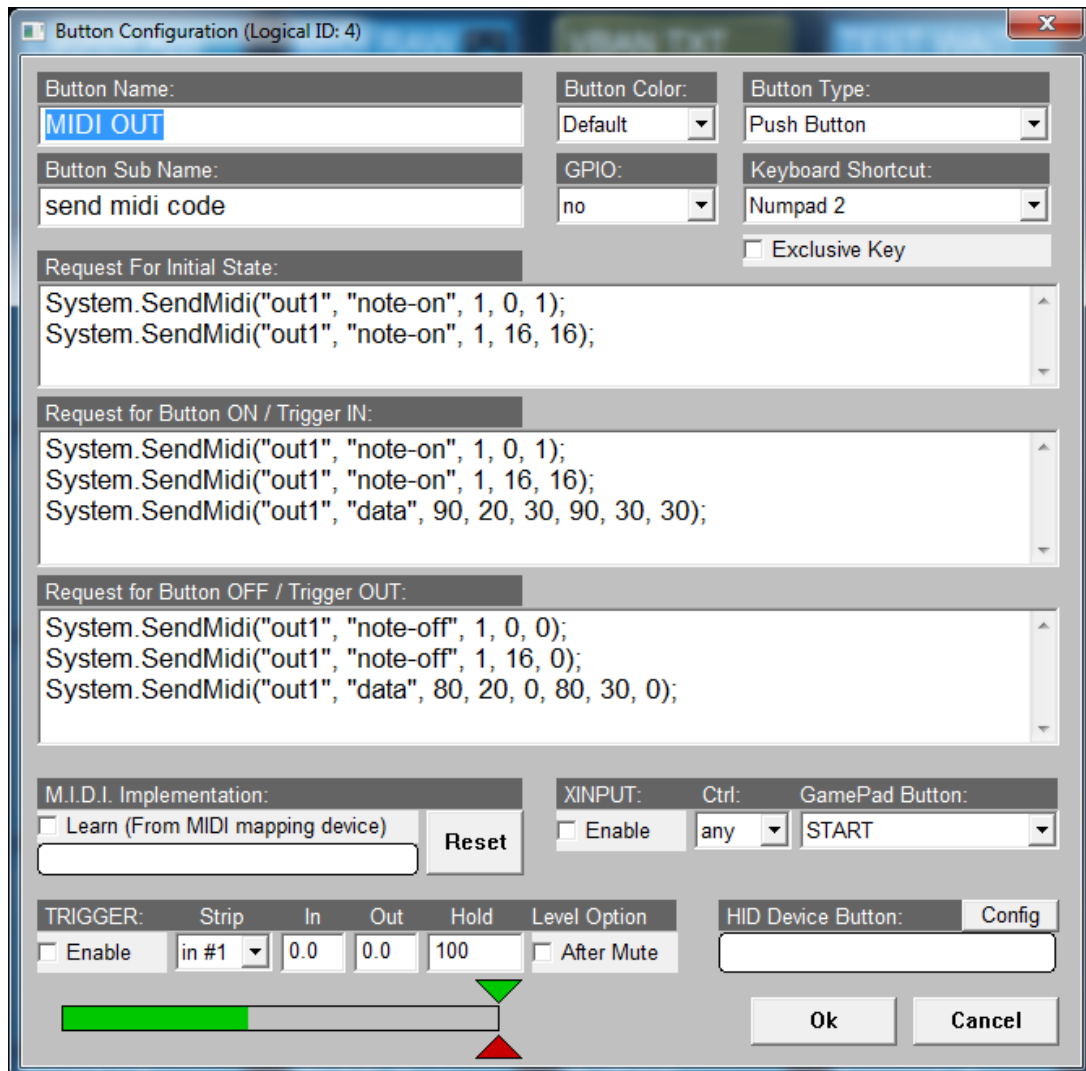

With October 2020 versions, it is possible to use directly the instruction SendMidi without "system" prefix:

```
SendMidi("out1", "note-on", channel, note, velocity);
SendMidi("out1", "note-off", channel, note, velocity);
SendMidi("out1", "ctrl-change", channel, ctrl, value);
SendMidi("out1", "prg-change", channel, nPrg);
```

Send VBAN-MIDI or VBAN-TEXT (Voicemeeter script)

With Voicemeeter version 1.0.3.5 / 2.0.3.5 it is possible to send MIDI message through VBAN-MIDI and Voicemeeter Script through VBAN-TEXT protocol. And the MacroButton application can also learn MIDI code coming from incoming VBAN-MIDI stream. Note that MIDI2VBAN application is also installed with Voicemeeter to convert physical MIDI I/O into VBAN-MIDI Stream.

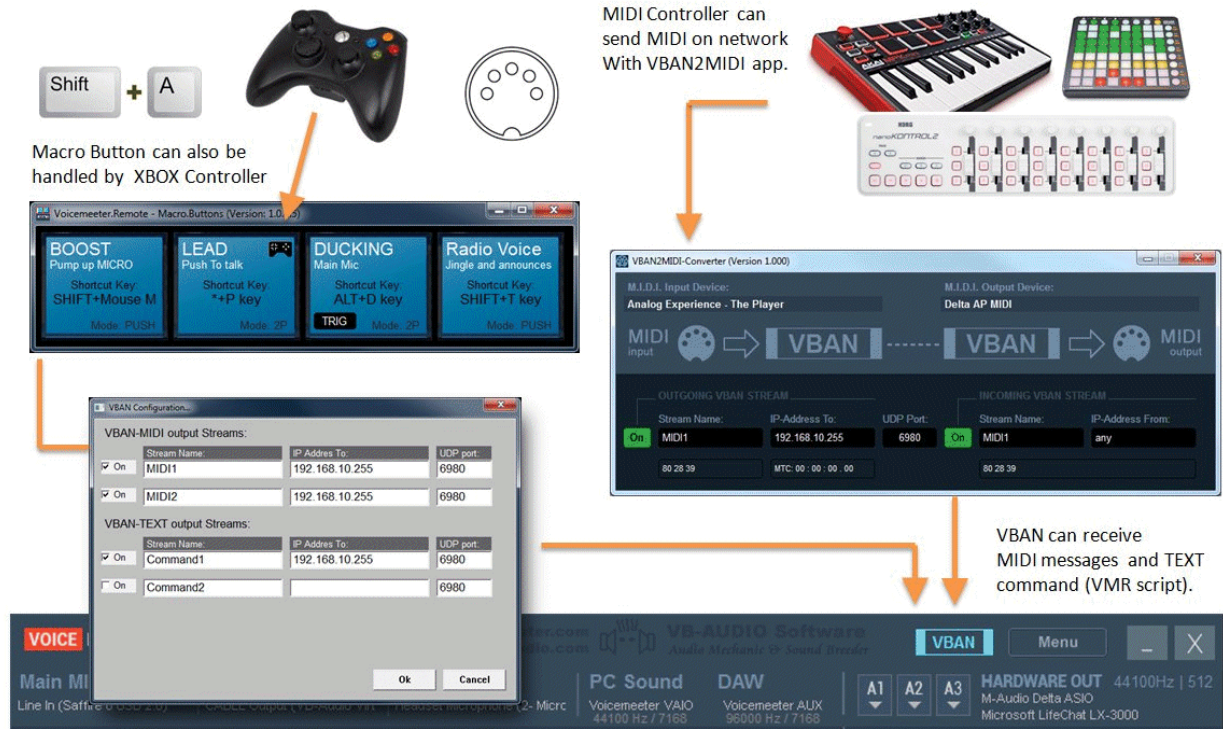

To send message through VBAN protocol, you have first to activate and configure your VBAN output streams. This is located in MacroButton system menu: VBAN Configuration Dialog Box will allow to setup 2x VBAN MIDI streams and 2x VBAN TXT Streams:

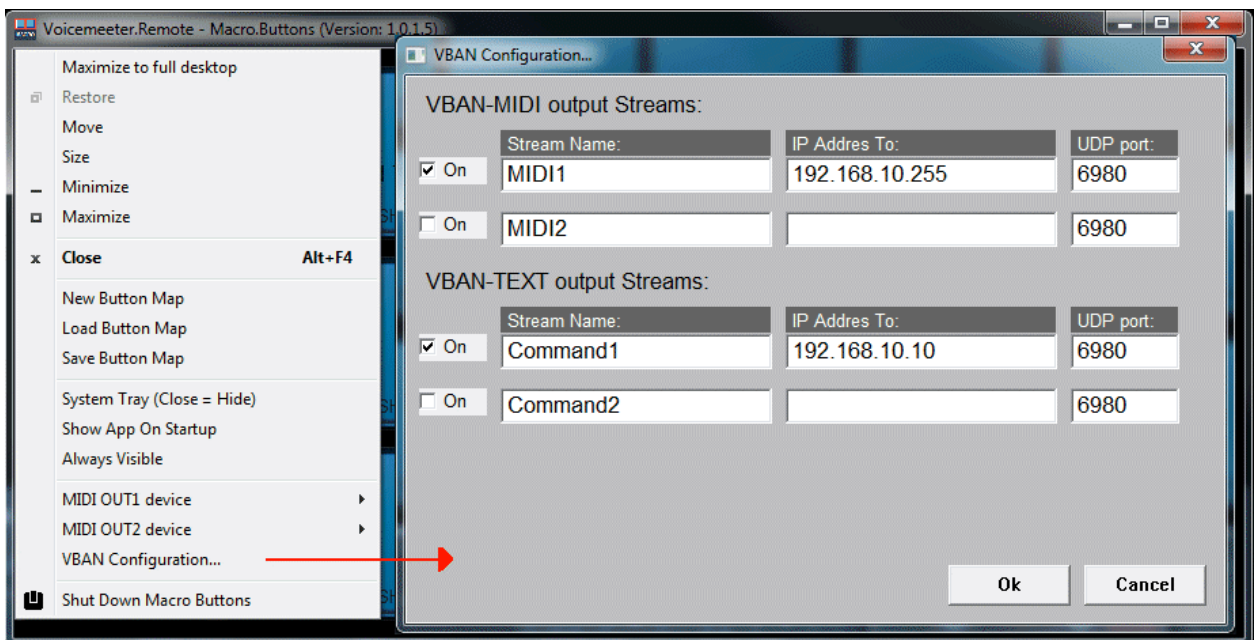

Send MIDI command through VBAN Stream

Once you have configured output VBAN MIDI Stream, you can use the same instruction to send MIDI message to VBAN1 or VBAN2 stream:

4x request types are implemented (channel 1 to 16):

```
System.SendMidi("vban1", "note-on", channel, note, velocity);
System.SendMidi("vban1", "note-off", channel, note, velocity);
System.SendMidi("vban1", "ctrl-change", channel, ctrl, value);
System.SendMidi("vban1", "prg-change", channel, nPrg);
```

There is also a RAW DATA function to send any M.I.D.I. Message (including sys-ex).

```
System.SendMidi("vban1", "data", aa, bb , cc, ee, ff, gg, ...);
```

Send Voicemeeter TEXT Request through VBAN Stream

Once you have configured output VBAN TEXT Stream, you can send a command script by using a section bloc starting by BEGIN_SECTION and ending by END_SECTION instruction:

```
BEGIN_SECTION("vban1")
Strip(0).mute=1; Strip(1).mute=1;
Bus(0).gain= 0.0;
END_SECTION
```

All Voicemeeter script written inside the section will be sent to VBAN1 TEXT Stream defined in the VBAN configuration Dialog Box. While the section below will send the script through VBAN2 TEXT stream:

```
BEGIN_SECTION("vban2")
Strip(0).mute=1; Strip(1).mute=1;
Bus(0).gain= 0.0;
END_SECTION
```

Regular function style syntax is also possible (to fit the syntax used in VBAN-Button app for Android):

```
SendText("vban2",Strip(0).mute=1; Strip(1).mute=1;Bus(0).gain= 0.0;);
```

Or written on several lines as well: last parenthesis will close the entire request.

```
SendText("vban2",
Strip(0).mute=1;
Strip(1).mute=1;
Bus(0).gain= 0.0;);
```

Manage your lights Network in DMX 512

With Macro Buttons 1.0.2.7 it is possible to send DMX 512 requests through a DMX serial interface (COM) selected in DMX configuration dialog box in MacroButtons system menu by a simple set of 2 functions:

The simple function to set a DMX value according device address and channel:

```
System.DMXSetValue(addr, channel, value);
```

or can be used with several values which will automatically fill the next channels:

```
System.DMXSetValue(addr, channel, value1, value2, value3, value4...);
```

To send the newly modified DMX frame:

```
System.DMXCommit();
```

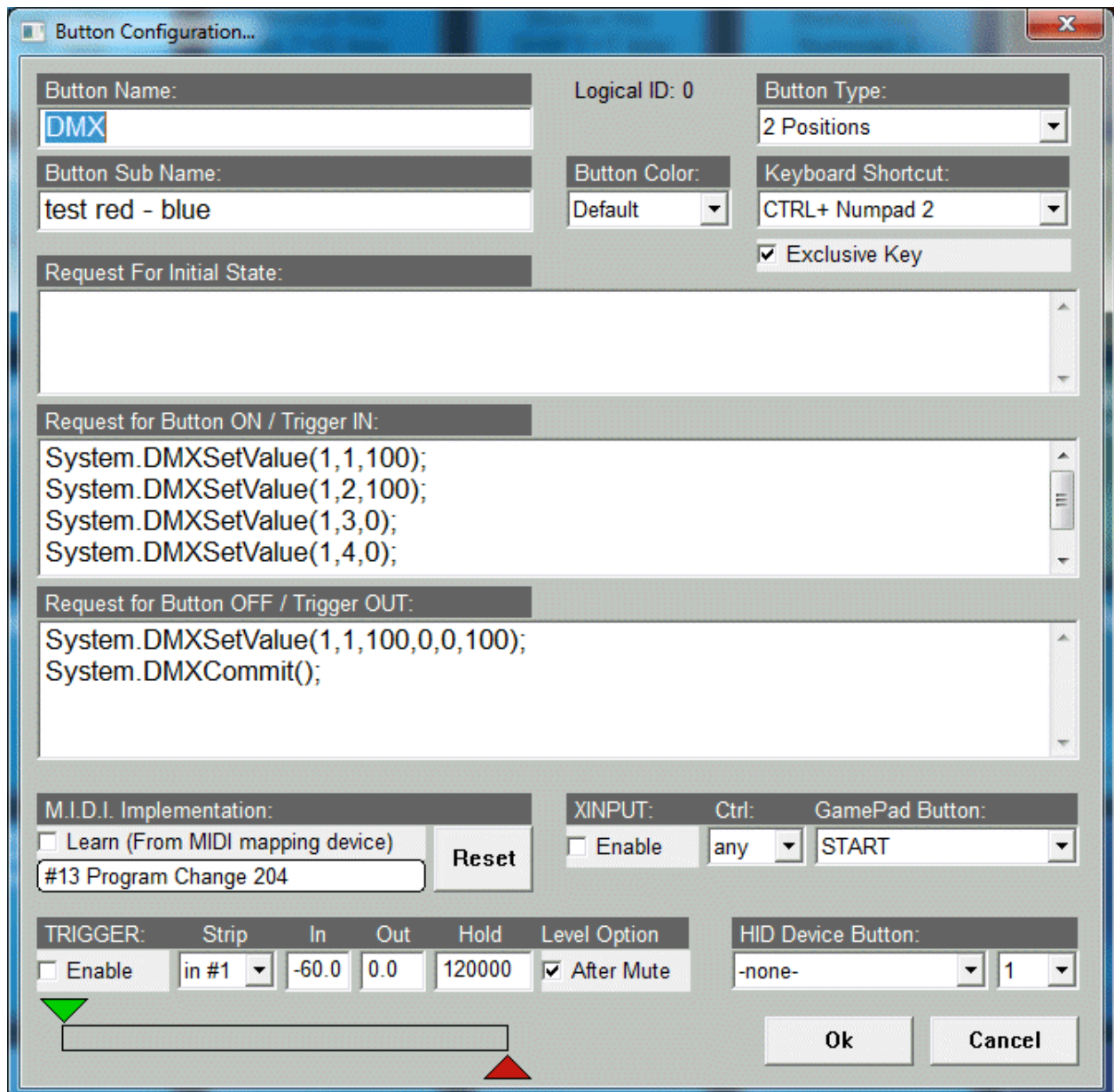

Example of tested DMX serial interface: Enttec Open DMX USB Interface.

Voicemeeter Remote API (for developer only)

The requests described above are based on Voicemeeter remote API (delivered and installed with Voicemeeter as VoicemeeterRemote.dll). This API can be used by any third part application programmed in any language to control Voicemeeter and take advantage of all its features.

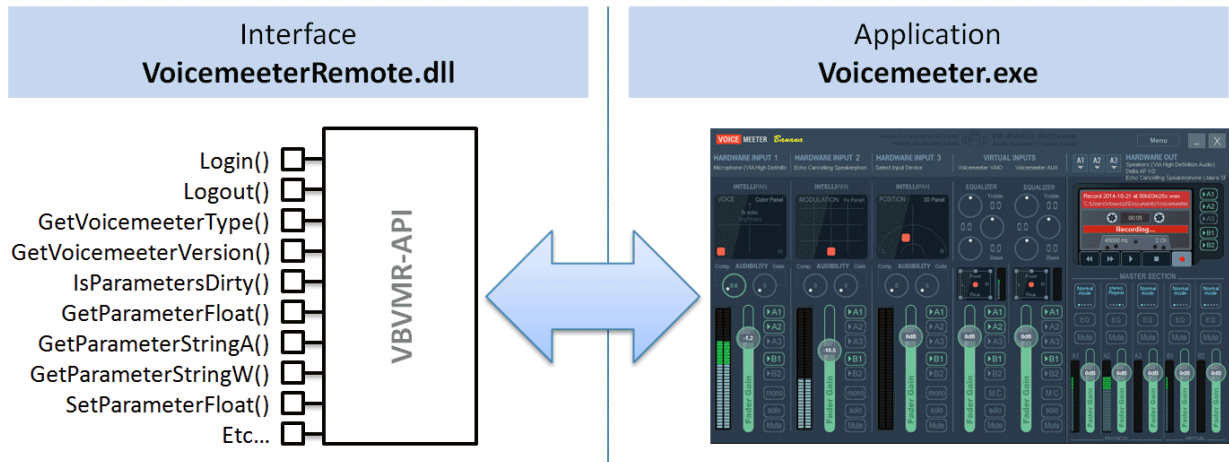

Up to 4 Clients Applications, to remote Voicemeeter or Banana version

Since Voicemeeter 1.0.5.0 / 2.0.3.0, Voicemeeter Remote API provides an AUDIO API to process audio inside Voicemeeter in 3 Different point. Download SDK and get more information on our forum: <https://forum.vb-audio.com/viewtopic.php?f=8&t=346>

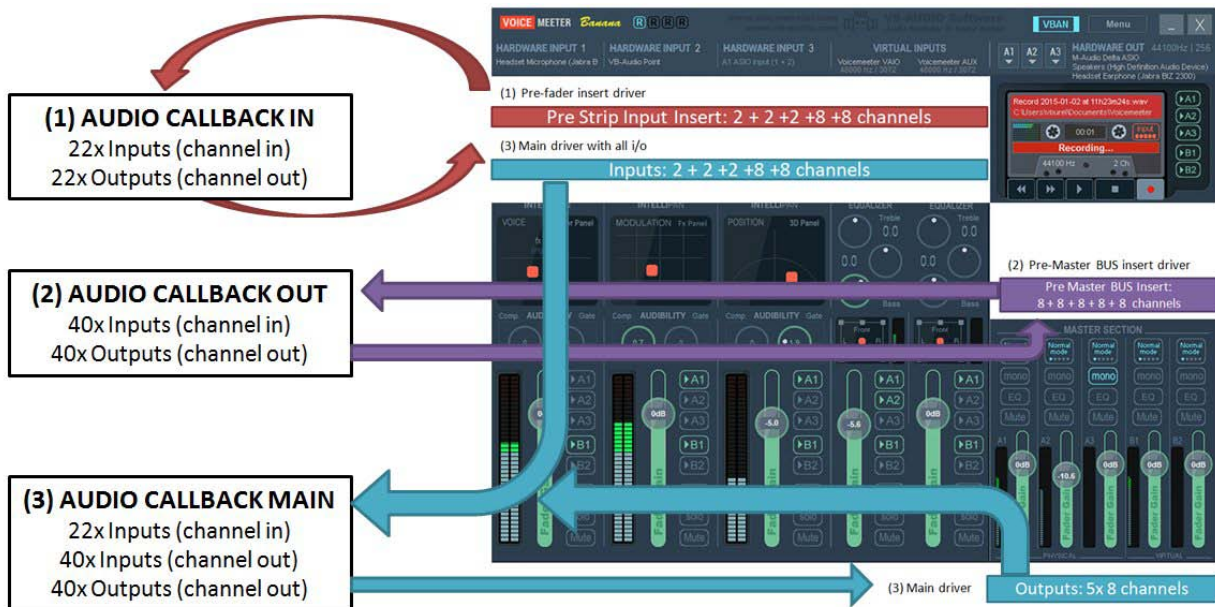

EXTRA OPTIONS

Voicemeeter Latency

M.I.D.I. Mapping

Specifications

Known issues

Command line Installation

System Settings / Options

Open the following System Settings Dialog Box by the menu:



This modal dialog box will show you the status of the different audio devices currently used by Voicemeeter Banana.

- **SR**: is giving the current samplerate of the device (which can be different for each device, Voicemeeter is based on multi points and multi formats audio engine able to manage most of audio system configurations).
- **buf** gives the current buffer size used by the audio device (Voicemeeter Audio engine support different buffering on all audio points).
- **Ch**: gives the number of channel managed by the devices (Voicemeeter can manage 1 to 2 channels on inputs and up to 8 channels on outputs).
- **r** : gives the bit resolution of the device (Banana uses 24bits resolution per default).
- **S**: means "share mode" (applicable for WDM device only. KS is usually in exclusive mode and MME in share mode. For WDM it depends on devices and audio engine mode).

Note: Output A1 device configuration gives the main audio configuration of Voicemeeter and the configuration of Voicemeeter virtual ASIO driver (Sample rate and buffer size). It also means that all audio processing done in Voicemeeter will be based on this sample rate (if some audio points work in another sample rate, conversion will be done automatically to this main sample rate.).

In this dialog box, you can change the latency used by MME, WDM and/or KS audio drivers. Basically MME driver support buffering between 512 and 2048 samples , while WDM and KS can go down to 256 samples (that makes audio processing very closed to the real time – practically usable to sing on a song in real time – karaoke – or to play digital piano on music in real time).

Some PC configurations (or some audio devices) will work very well with minimal buffering values while other will not (the sound stream could be not stable and generates too much sound's cut). That's why per default MME device uses 1024 samples buffering while WDM device is using 512 samples (these default settings should work for 100% PC configuration cases).

Under Windows XP, WDM driver are not available. (That we call WDM driver is audio device driver that can be handled by Microsoft WASAPI, for better audio performances and quality). But some audio device can support KS interface and then provide low latency support.

Preferred Main Sample Rate can be used as a wish to make Voicemeeter run output device A1 in the wanted sample rate (44.1, 48, 88.2, 96, 176.4 or 192 kHz). But it also depends on the audio device current configuration.

Engine mode provides a SWIFT mode to possibly improve real time (experimental option). WDM Input devices are driven in SHARED mode per default to avoid possible WASAPI Exclusive mode bug (see known issues). These both modes have been disabled because generating too much support.

ASIO Driver support:

Voicemeeter can use an ASIO driver as Output A1 (the main output) to run in audio pro conditions (like any DAW using ASIO device).

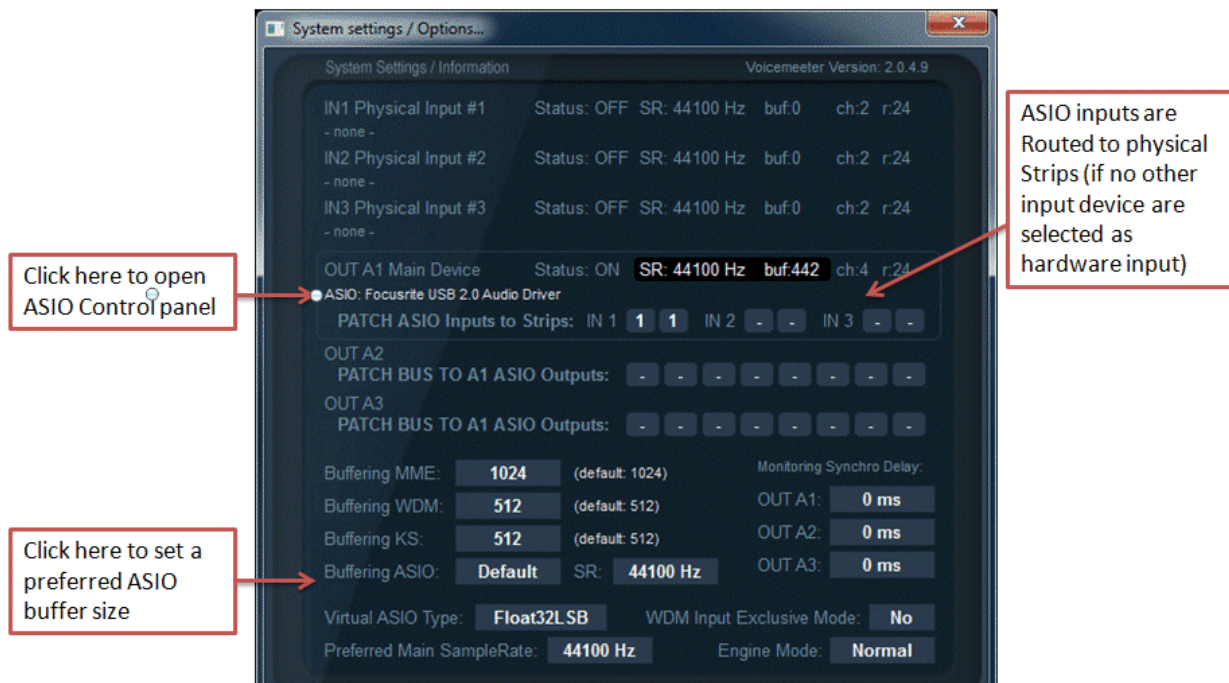

If ASIO device is selected as output A1, Voicemeeter will send audio to the 8 first output channels. Other BUS could be routed to other ASIO output channels. It is also possible to get the first input channels of the ASIO device routed to Hardware Inputs of Voicemeeter. This is done by the ASIO PATCH allowing to select which ASIO channel will be used for IN#1 left & right, IN#2 left and right...

ASIO Buffering and ASIO samplerate are pending on two parameters:

- Buffering ASIO can use the default buffer size (given by ASIO driver) or be forced to a given buffer size (but the ASIO driver can refuse or not work correct for some values).
- SR parameter allows to use the default sample rate given by the ASIO driver or to force the sample rate defined by the preferred sample rate.

It is also possible to open the ASIO Control panel of the main output device by clicking on its name.

Getting Optimal Latency:

The choice of the Output A1 is critical to get the best global latency, since it gives the master sample rate and main buffer size. So we recommend to select your best audio device as output A1 (preferred ASIO if possible, WDM or KS otherwise) – with ASIO device the buffer size is given by the ASIO driver itself (that can usually be set by the ASIO Specific Control Panel of your audio board). But it is possible to specify a preferred ASIO buffer size (used if the driver accepts it).

To improve latency, you can also decrease the latency buffer size (for example down to 256) especially with WDM or KS devices. If using WDM devices, you can again reduce global latency

(the time between microphone and speaker) by using SWIFT mode (but not recommended because might be unstable).

DISABLED OPTION: Activating WDM Input Exclusive mode (and Swift mode) will force audio engine to use smallest buffer with WDM input devices. But this exclusive mode could not be stable and produce various potential problems in the time (from audio crash to system freeze/crash – pending on audio driver and O/S – see known issues section at the end of this document).

Virtual I/O latency can also be optimized by decreasing the Internal Latency of the Voicemeeter VAIO driver by using specific VBCABLE Control Panel program. However decreasing internal latency can produce discontinued or non-working stream in some cases, pending on different buffering constraints (see VB-CABLE technical documentation).

Virtual ASIO driver are adding a single buffer to the global latency (the size of this buffer is given by the buffering of the output A1)

LATENCY WARNING:

CHANGING DEFAULT LATENCY, BY REDUCING BUFFER SIZE CAN DECAY THE AUDIO STREAM, BRING UNSTABILITY, FREQUENT AUDIO CUT, STATIC, SYNCHRO LOST (ROBOTIC VOICE).

If you get such problem, come back to default buffer size.

Patch Composite

Patch composite allows selecting inputs used in the 8 channels of the composite mode. It's possible to switch PRE-FADER input to POST-FADER inputs by click on "Select Pre-Fader inputs...".

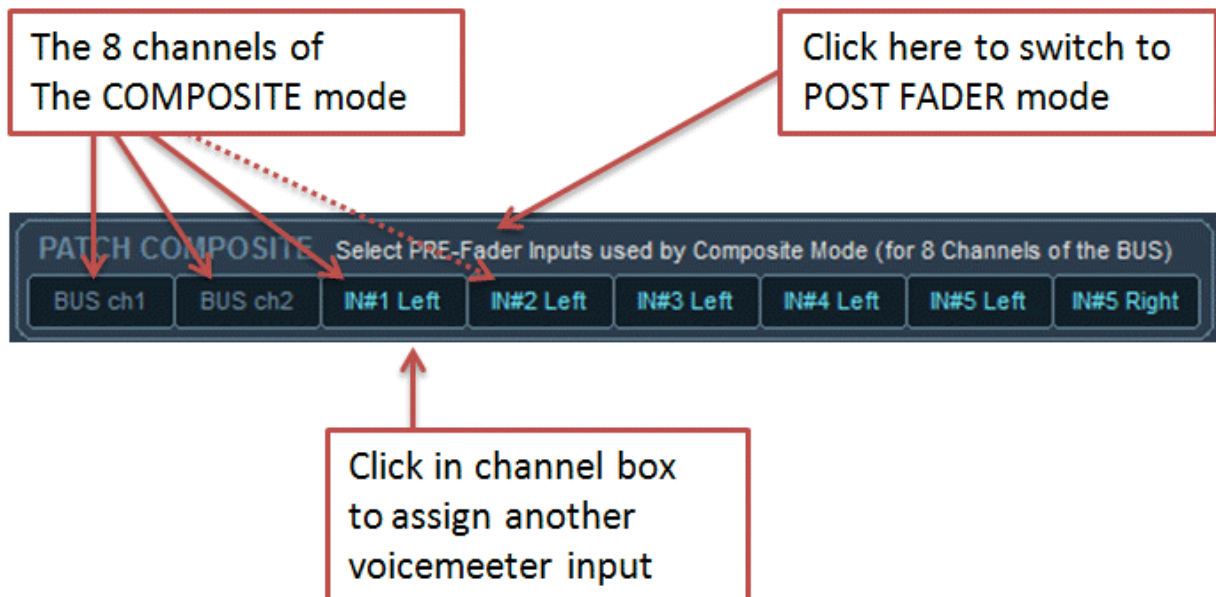

The COMPOSITE Mode is used to get a composite signal on a BUS and be able to send or record different channels, composed by given inputs (see USE CASE #3 in Voicemeeter User Manual).

Patch Insert

The Patch Insert allows activating insert for each input channel. This is applicable only if an application is connected to the Voicemeeter Insert ASIO Virtual Device Driver. This driver supports a single client to work as a pre-fader insert on possible 22 channels composing the 5 strips of Voicemeeter. Then it's possible to use a VST Plug-in Host for example to insert plug-ins on any Voicemeeter inputs.

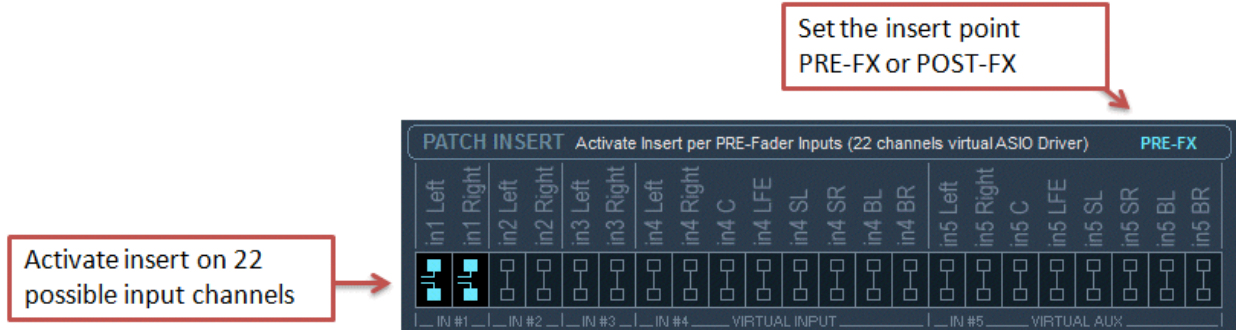

If a DAW or any ASIO application is connected to Voicemeeter Virtual Insert ASIO Driver, a small 'i' icon appears on top left of each strip to let you see or set which INSERT Return is activated.



We made successful test with Minihost Modular Application (from Image Line Company: www.image-line.com)

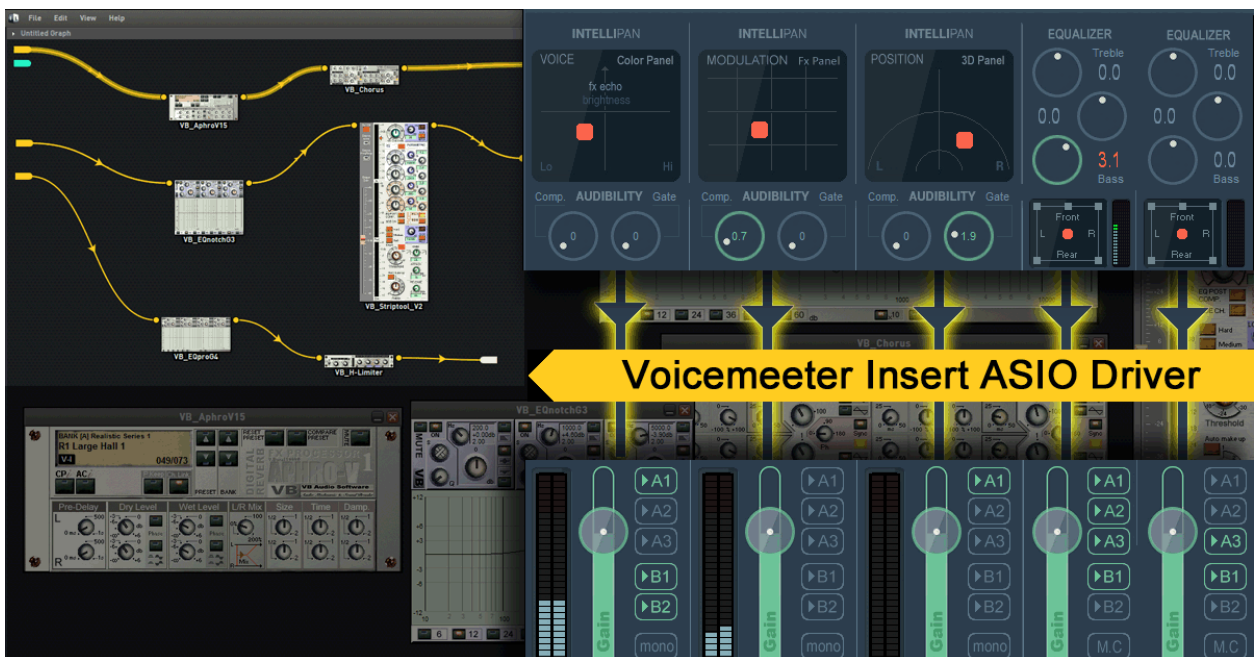

Here the virtual insert is POST-FX (but always PRE-FADER).

M.I.D.I. Mapping:

Voicemeeter allows connecting a MIDI remote surface to control gain, mute, solo buttons of every strips and busses (with MIDI Feedback) and a secondary MIDI Controller (MIDI Extra Input Device).



You just need to select the right MIDI device and enter in Learn process to configure the M.I.D.I. Mapping. This is expected to work with any M.I.D.I. Remote. You can even give a title to your mapping and store it on disk or recall it from XML files.

Click on Learn (use TAB or up/down arrow key to learn next/previous control) and move your M.I.D.I. Control. Click on M.I.D.I. Code area (black) to reset the M.I.D.I. Implementation (as it was before learning process).

PTT option means “Push To Talk” and un-mute the related strip when pushing the button, mute it when release it.

RESET MAP: reset entire M.I.D.I. mapping

LOAD / SAVE allow to recall and save M.I.D.I. Map from or to file (xml file).

REFRESH Controller: allows to send all MIDI message related to the current Voicemeeter state. This feature also exists as MIDI function (assignable to a MIDI button) – see last MIDI Mapping page.

M.I.D.I. Map name is a name defined by user to identify precisely the remote surface (stored in M.I.D.I. Map XML file).

MIDI Feedback:

With e March 2021 Version Voicemeeter manages a MIDI Output Device to send back MIDI code and move motorized Fader or highlight LED Button. This is made automatically with the 'F' or 'FF' mode.



F: Simple feedback:

The single 'F' mode is for simple feedback. The MIDI controller is receiving MIDI message when there is a change on related control only, but change made by Mouse or VBAN request or anything but the MIDI controller itself. 'F' Mode is usually enough for movable control like knobs and faders... But some remote surface can use motorized fader needing a MIDI feedback to confirm the position (like a acknowledgement) in this case 'FF' will be needed.

FF: double feedback:

Double feedback is useful for MIDI controller LED Buttons. When you push a LED button, it must change its color to fit the state of the related Voicemeeter button. So it needs double feedback: FF. Some motorized fader can also require this mode to acknowledge the position (otherwise the fader automatically goes back to initial position . this is pending on remote surface type).

MIDI Forward:

MIDI mapping can get MIDI message from two different MIDI controller and from VBAN-MIDI Stream. All received MIDI message are also forwarded to MacroButtons application.

With March 2021 version, it is possible to also forward MIDI message through an outgoing VBAN MIDI stream (see VBAN Configuration Dialog box: last outgoing stream is a MIDI Stream). This is made to forward MIDI message on network (including MIDI feedback if your MIDI controller is on other computer).

MIDI Advanced Feedback:

With the November 2022 Version Voicemeeter MIDI mapping allows to define feedback value for 2 positions control. Per default the feedback value is 127 for ON and 0 for OFF state, but for MIDI control able to display different colors, it can be interesting to define other value here.

RIGHT CLICK on 'F' button to open the MIDI Feedback Options dialog box.

It is possible to define complex MIDI feedback message (including SYS-EX) to send MIDI command to other MIDI device, or MIDI LCD or MACHINE CONTROL...

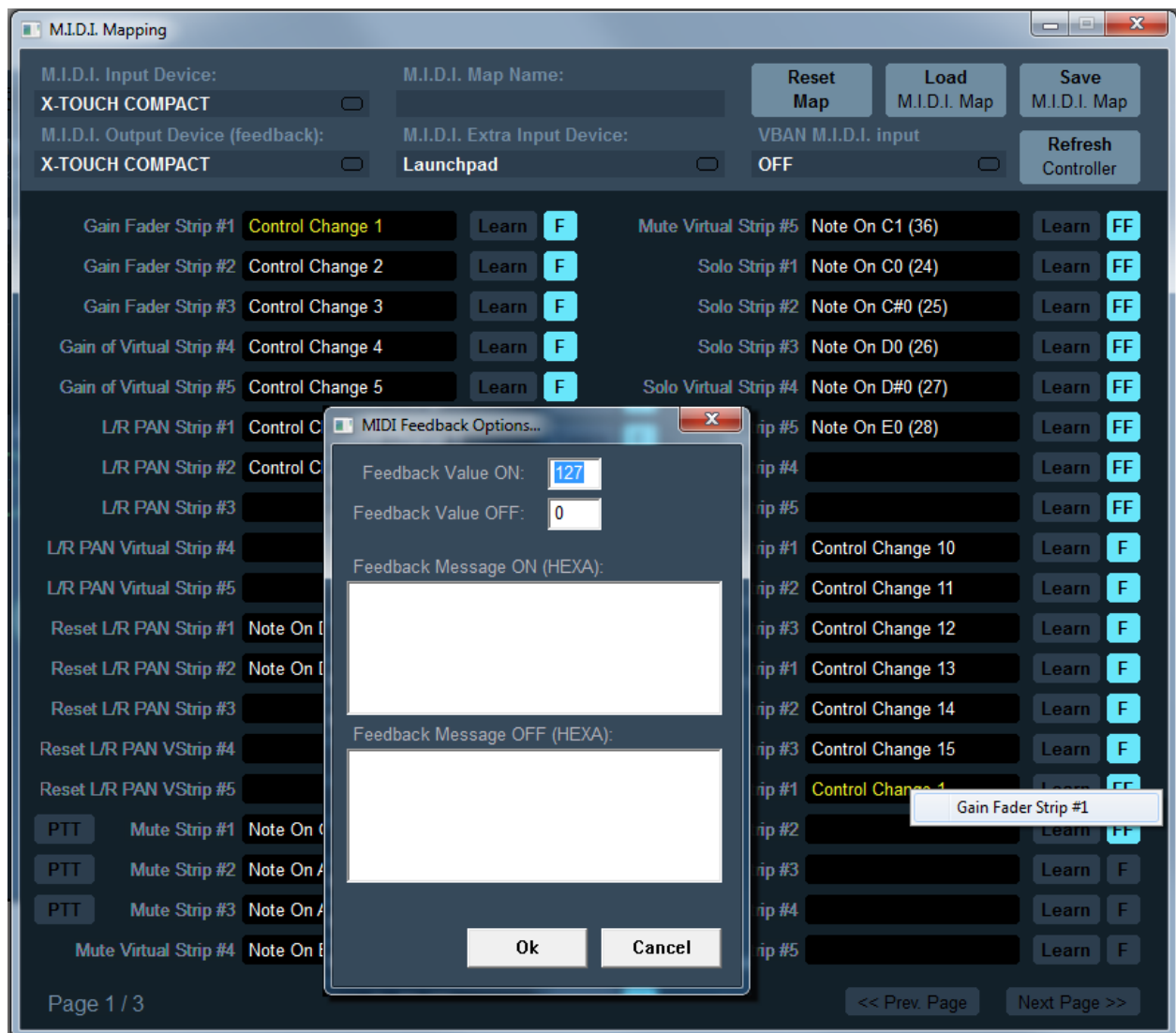

MIDI messages displayed in yellow mean this message is already used by one or several other MIDI map parameters. RIGHT CLICK on it to get the first parameters using the same MIDI message.

Specifications:

Device Type:	PC-Core Virtual Audio Mixing Console
Compatibility:	Windows XP, VISTA, WIN7, WIN8, WIN10 (32 / 64 bits)
PC Configuration:	Min: Celeron / Duo Core 1.8 GHz - 512 MB RAM - Disk < 100 MB
Number of Audio Device I/O:	5 Inputs (3 physicals / 2 Virtual). 5 Outputs (3 physicals / 2 Virtual)
BUS / Layer:	5x BUS (A1,A2,A3 and B1, B2) / Single Layer
Audio Engine Capabilities:	32, 44.1, 48, 88.2, 96, 176.4 or 192 kHz DSP Processing (defined by Output A1 configuration)
Output A1 (Main):	WDM, KS, MME, ASIO (32 kHz to 192 kHz) - 1 to 8 channels
Output A2:	WDM, KS, MME (8 kHz to 192 kHz) - 1 to 8 channels
Output A3:	WDM, KS, MME (8 kHz to 192 kHz) - 1 to 8 channels
3x Physical Inputs:	WDM, KS, MME (8 kHz to 192 kHz) - mono or stereo.
2x Virtual I/O:	WDM, KS, MME, DirectX, WaveRT (8 kHz to 192 kHz) 1 to 8 channels 8 channels on virtual input, 2 on virtual outputs.
2x Virtual ASIO I/O:	ASIO (32 kHz to 192 kHz) 8 Channels (in and out) / 4x Client Applications. Virtual ASIO configuration is given by Main Output A1 (SR and Buffering)
1x Virtual Insert ASIO I/O:	ASIO (32 kHz to 192 kHz) 8 Channels (in and out) / single Applications. Virtual ASIO configuration is given by Main Output A1 (SR and Buffering)
M.I.D.I. Implementation (remoting):	Gain faders, Mute, Solo, M.C, Audiobility, 3 Bands EQ, Transport. (Configuration by Learn process).
Strip Processing:	<ul style="list-style-type: none"> - "Color Panel" Control (Equalization). - "Modulation" Control (Chorus). - 3D Panoramic Control (source positioning by binaural effect). - Audibility Knob Compressor. - Audibility Knob Gate effect. - 3 Bands Graphic Equalizer (on Virtual Input). - Limiter (threshold on meter bar). - Mute / Solo.
BUS Processing:	<ul style="list-style-type: none"> - Integrated 0 dBfs Limiter and Peak Remover. - Mix Down to convert 5.1 or 7.1 to Stereo. - Stereo Repeat (Stereo signal copied on channel 3,4 / 5,6 / 7,8) - Master Full Parametric EQ (6 Cells / 8 channels). - Mute / Mono
Others:	- Physical Output Synchronization Delay in system settings dialog box.

Voicemeeter Banana I/O Diagram:

Like a regular mixing console, Voicemeeter Banana can be represented with a usual I/O Diagram even if connections are not made by real wire, principles stay the same.

Note that Virtual I/O provide Windows Interface (MME, KS, WASAPI, DirectX...) and ASIO Interface (defined by Steinberg gmbh). It allows connecting regular windows audio application as well as audio pro DAW using ASIO devices only.

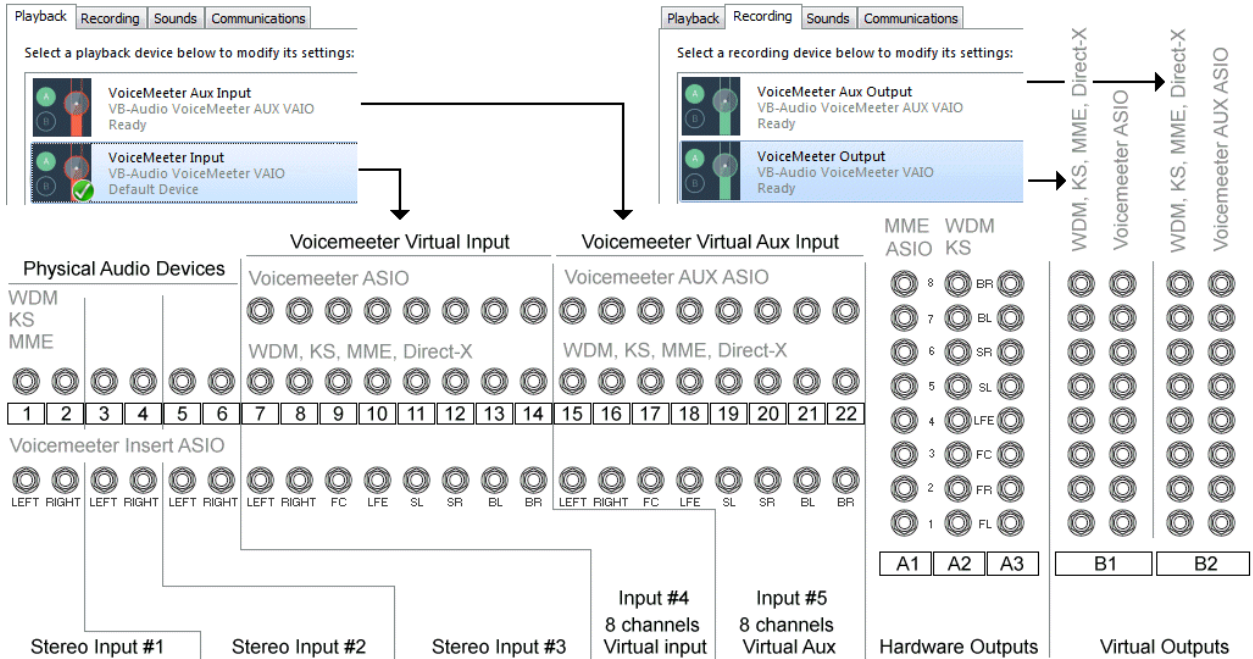

KNOWN ISSUES / RECOMMENDATIONS

Voicemeeter has been validated on different levels and should work 100% in most configurations. However we have notified some few issues, mainly related to general system configuration and Windows Audio Scheme understanding.

No sound anymore on my computer!

Voicemeeter is like a mixing console, it must be connected correctly to work correctly. If you set Voicemeeter audio device as default device, Voicemeeter must be running (like switching ON your mixing console) otherwise there might be no sound on your computer. When Voicemeeter is running, it can get exclusive access to selected output device (A1, A2, A3...) and prevent other applications to use these playback devices. As Virtual Audio Mixer, all audio sources should be connected to Voicemeeter to avoid possible conflict. When you connect your mixing console to your amplifier, you connect nothing else to this amplifier and all sources are connected to your mixing console. It's the same with Voicemeeter.

Voicemeeter does nothing if you don't use it

Voicemeeter application and Voicemeeter virtual audio device drivers do nothing if you don't use them and they cannot disturb or corrupt your system. If there is no sound anymore, it's because a bad audio configuration. Then you just have to check your default audio device in Windows Control Panel / Sound Dialog Box (what is your default playback or communication device? What is your default recording device ?...), and check the audio configuration of some possible application that you previously configured to work with Voicemeeter (typically Skype).

Output A1, A2 ... are not exactly synchronized.

On Voicemeeter every i/o are independent and we can hear more or less delay between them, especially when using 3 different audio output devices: if A1,A2 and/or A3 are routed to 2 or 3 audio devices, the sound might be not exactly synchronized (one speaker output can be late and produce a small echo with other speaker output). This is normal (according technical constraint) but can be corrected by compensate one audio output with a delay line (see System Settings Dialog Box).



Voicemeeter Audio Stream can be stopped (no more sound, no meter display).

It can happen when changing audio system configuration (in Windows Control Panel / Sound properties) or when plug or unplug USB device or when launching other program that could use same audio device ... In this case, simply restart audio engine or re-select an audio device out A1 or input 1 or any other in Voicemeeter. It will restart audio stream automatically (otherwise it could mean that audio device are used by other process and cannot be used anymore by Voicemeeter).

Voicemeeter Audio Engine works only if a device has been selected for output A1. This is defining the main audio stream and if the output A1 device is disconnected or stop working, other stream or VBAN stream will stop working too.

Audio Stream becomes bad (sound is choppy, crackling, discontinued):

If the audio stream is not stable in the time, with too much cut in the sound, it means you did not find the right audio configuration and you must try to change audio interface or buffer size to get stable audio stream. Some application like Discord could not work correct with other sample rate than 48kHz so you may set Voicemeeter Virtual output (recording device) used by Dsicord in 48 kHz.

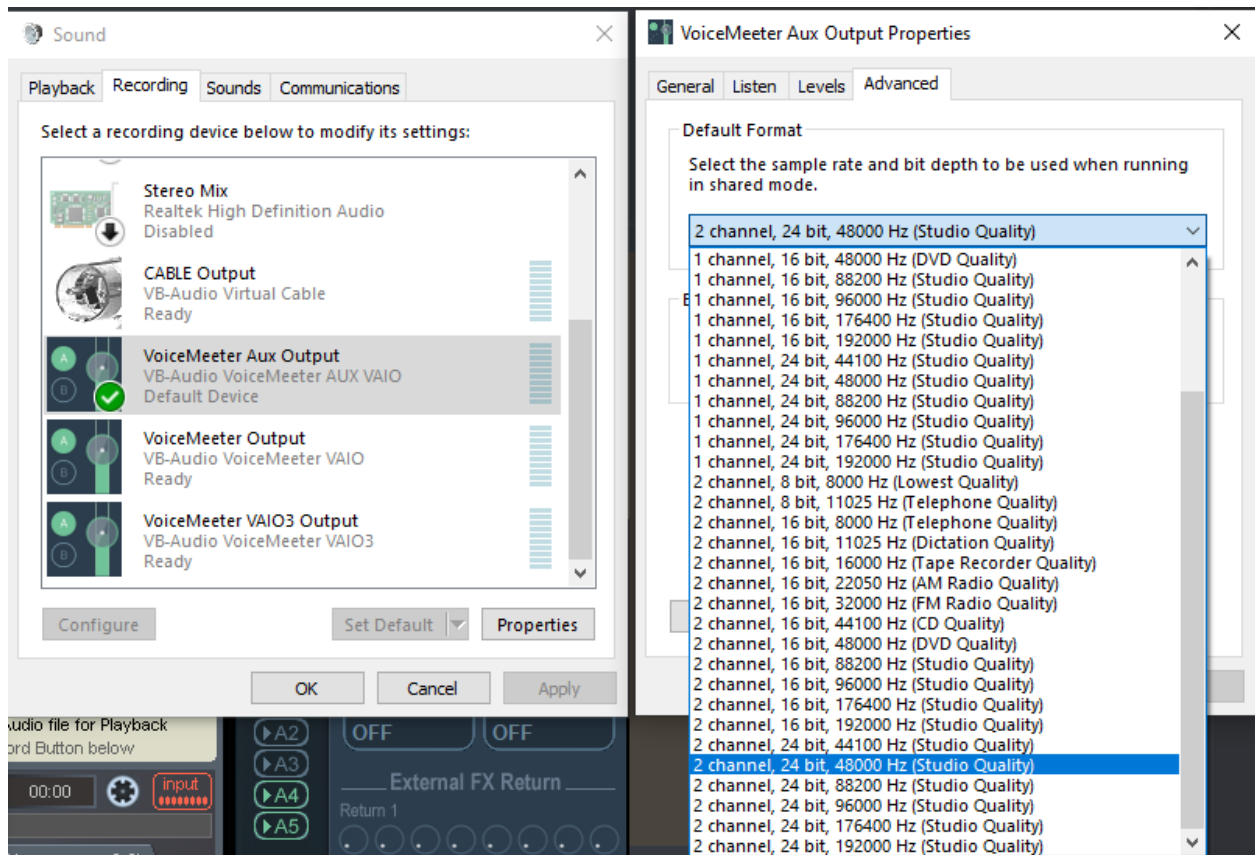

Windows Update can disturb the audio stack:

In some cases, WIN10 or WIN11 update can bring some problems by re-installing our virtual audio driver in bad way. In this case you may consider re-install Voicemeeter (and VB-CABLE if any) correctly by following the UPDATE procedure given in the first pages of this documentation.

More infor on our forum topic:

<https://forum.vb-audio.com/viewtopic.php?f=6&t=442>

VB-Audio Device Checker:

Voicemeeter run the VBDeviceCheck.exe on startup to check if all VB-Audio virtual audio driver installation remains correct. If there is a problem a warning message is displayed: "Bad Driver Installation Detected". Then you can decide to ignore it or try to understand the problem and fix it by re-installing Voicemeeter or VB-CABLEs.

This checking has been done to detect a problem of re-installation by Win10 or Win11 automatic update that can re-install audio driver not correctly. To detect this problem, the Device Checker check the Icon, pin Name and different driver information expected to not change.

Consequently, if you change our Virtual Audio device Icon or Pin name, it will be interpreted as a potential consequence of a Bad Driver installation.

This VBDeviceCheck program can also be launched by the Voicemeeter menu to get access to different information:

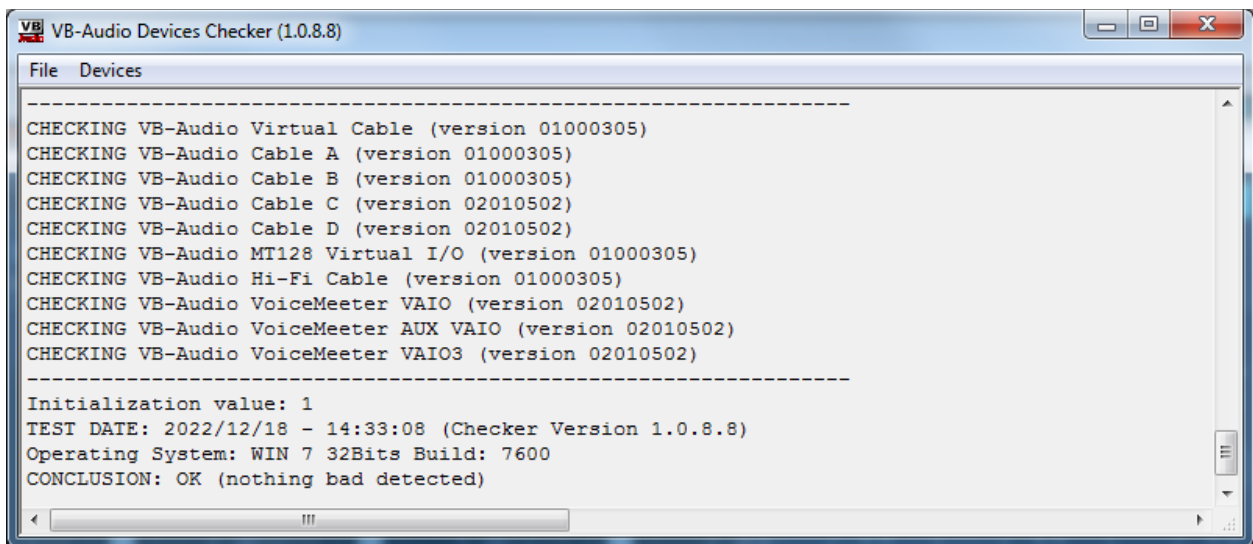

```
VB-Audio Devices Checker (1.0.8.8)
File  Devices
-----
CHECKING VB-Audio Virtual Cable (version 01000305)
CHECKING VB-Audio Cable A (version 01000305)
CHECKING VB-Audio Cable B (version 01000305)
CHECKING VB-Audio Cable C (version 02010502)
CHECKING VB-Audio Cable D (version 02010502)
CHECKING VB-Audio MT128 Virtual I/O (version 01000305)
CHECKING VB-Audio Hi-Fi Cable (version 01000305)
CHECKING VB-Audio VoiceMeeter VAIO (version 02010502)
CHECKING VB-Audio VoiceMeeter AUX VAIO (version 02010502)
CHECKING VB-Audio VoiceMeeter VAI03 (version 02010502)
-----
Initialization value: 1
TEST DATE: 2022/12/18 - 14:33:08 (Checker Version 1.0.8.8)
Operating System: WIN 7 32Bits Build: 7600
CONCLUSION: OK (nothing bad detected)
```

More info on our forum topic:

<https://forum.vb-audio.com/viewtopic.php?f=7&t=688>

Audio Device List:

VB-Audio Device Checker also offers the possibility to display all VB-Audio Virtual Audio device installed. Playback devices and recording devices are shown like in Windows Sound dialog box with their current default audio format for the pin and audio engine (in parenthesis).

RUN THIS APPLICATION IN ADMINISTRATOR MODE if you want to use the different menu options to change sample rate format. The Device menu proposes to change the format in 44.1 kHz or 48 kHz for all playback devices, all recording devices or all devices (playback and recording). To change the audio format on a particular device input or output, simply right click on the device input or output to use the contextual menu.

RESTART YOUR COMPUTER AFTER, to be sure about the format change.

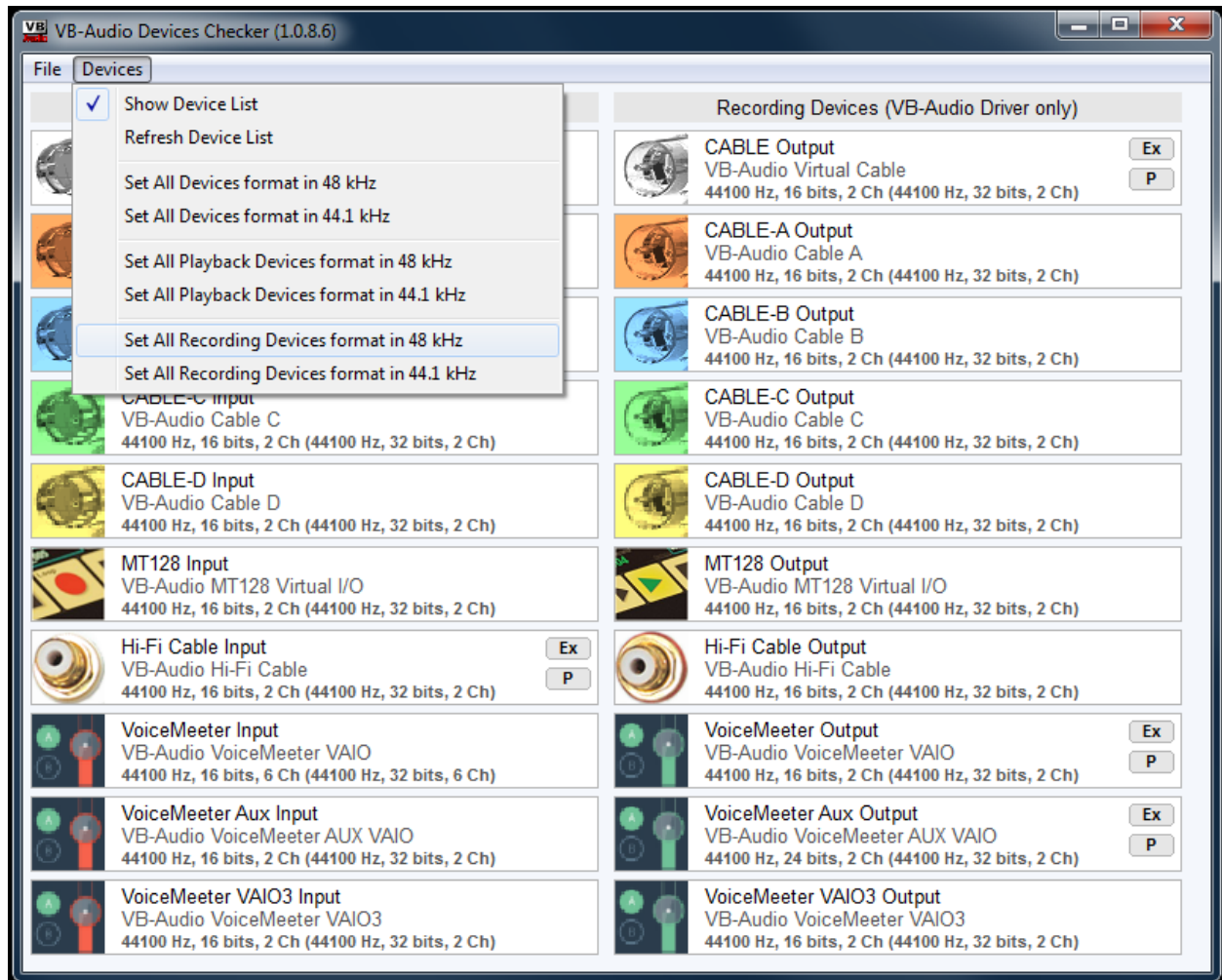

Command Line Installation:

It is possible to make an automatic installation (or uninstallation) by using command line options. However it will need to reboot after installation (and after uninstallation). So it's recommended to first call the setup program to uninstall possible previous version, then reboot, and then install new version (and reboot again).

-h : to hide GUI
-i : to install
-u : to uninstall

Voicemeeter Command Line:

Voicemeeter.exe and VoicemeeterPro.exe support some command to restart audio engine or to run Voicemeeter with a pre-defined configuration file. It allows for example to add different shortcut on the desktop to run Voicemeeter for different jobs.

To Restart Audio Engine by a shortcut use the following command line.

```
Voicemeeter.exe -R (or "-r")
```

It can be useful to restart audio engine from a shortcut, for example to re-activate a known USB headset already connected to one Voicemeeter hardware input, but not physically plugged to the computer. When re-plugged to the computer, Voicemeeter Audio Engine has to be restarted to make it work again.

To run Voicemeeter with a specific configuration file, use these following command lines (Voicemeeter must have been shut down before – if Voicemeeter is already running, it will do nothing):

```
-l"filename.xml" or -L"filename.xml"
```

If the xml is in the same directories of voicemeeter.exe

```
-l"filename.xml" or -L"filename.xml"
```

If the xml is in the same sub directories of voicemeeter.exe

```
-l"subfolder\filename.xml" or -L"subfolder\filename.xml"
```

Or you can use absolute path

```
-l"c:\folder\filename.xml" or -L"c:\folder\filename.xml"
```

Registry Parameters:

Some parameters in the registry (regedit) can be interesting for some expert users in very specific use case or rare technical problems. Do not modify these values without having getting advice on our support resource (forum, mail).

We are talking here about some values present in the following registry directory

`HKEY_CURRENT_USER\VB-Audio\VoiceMeeter`

`DelayedStartS`

This value gives the countdown in second before starting audio engine on Voicemeeter Startup (5 second per default). This is represented by a growing bar with a countdown displayed on the A1, A2... device selection area when launching Voicemeeter. This is done to let the time to all audio services and drivers to be started before Voicemeeter start its audio engine. If a driver is not ready when Voicemeeter Audio engine starts, this device won't work until restarting Voicemeeter Audio Engine (Menu -> Restart Audio Engine).

`preferredResolution`

This value gives the preferred bit resolution used by Voicemeeter Banana & Potato (24 bits per default). Voicemeeter Standard is always using 16bits per default with Windows Audio Interface. In any cases, the final bit resolution is the result of a negotiation with the audio interface (that can force to use other resolution than the preferred one).

`MaxMonDelayMS`

500 ms per default to optimize memory allocation, this value gives the maximum delay for BUS monitoring delay options (in the system settings dialog box). It can be redefined by this registry key in millisecond, from 500 ms to 5000 ms (5 seconds max).

WARNING: Other Registry Value, must not be modified directly.

AUDIO EXPERT / DEVELOPPERS

`EngineMode`

This value gives a bit field of feature related to WASAPI audio engine. Must be ZERO per default.

0x00000001 : MODE_SWIFT

0x00000100 : INPUT EXCLUSIVE MODE

0x00000200 : OUTPUT EXCLUSIVE MODE //set anyway in Voicemeeter